

#TL100191

INSTALLATION MANUAL

MS100262

APR Mk8 GTI to Golf R Turbo Upgrade

APR



Notes:

These instructions were written for a North American specification Mk8 Golf R, but other models, like the Arteon, Audi S3, etc, are similar.

When disassembling the car, be sure to keep all fasteners so they can be reused. It is recommended that you get some kind of compartmented tray to organize the fasteners, such as a fishing tackle box or several large ice cube trays. Fasteners that are not reused for reinstallation are noted in the instructions. All directions used in this manual (right, left, front, etc.) are based on if you were sitting in the drivers seat of the car.

These instructions assume that you have basic mechanical skills and several varieties of basic hand tools in order to install the kit. If you have any questions about the install, feel free to contact your APR representative.



WWW.GOAPR.COM

4800 US HWY 280 West Opelika Alabama 36801

TL100191



1) Securely place the vehicle on a lift or jack stands. While not required, it is a good time to do an engine oil service (leaving the new oil out of the engine until the installation is finished). The engine coolant can be drained. If you do not drain the coolant, some will be lost in the installation, but can be easily topped off after the installation. Also, changing spark plugs would be advised, as you should have almost all the pre-requisite work performed.

APR

2) Remove the two T25 screws from the front of the APR airbox. Loosen the 7mm nut on the clamp holding the airbox pipe to the back of the airbox and separate the pipe from the airbox. Slide the airbox back and then pull it up off the airbox mounting points to remove the airbox from the car.

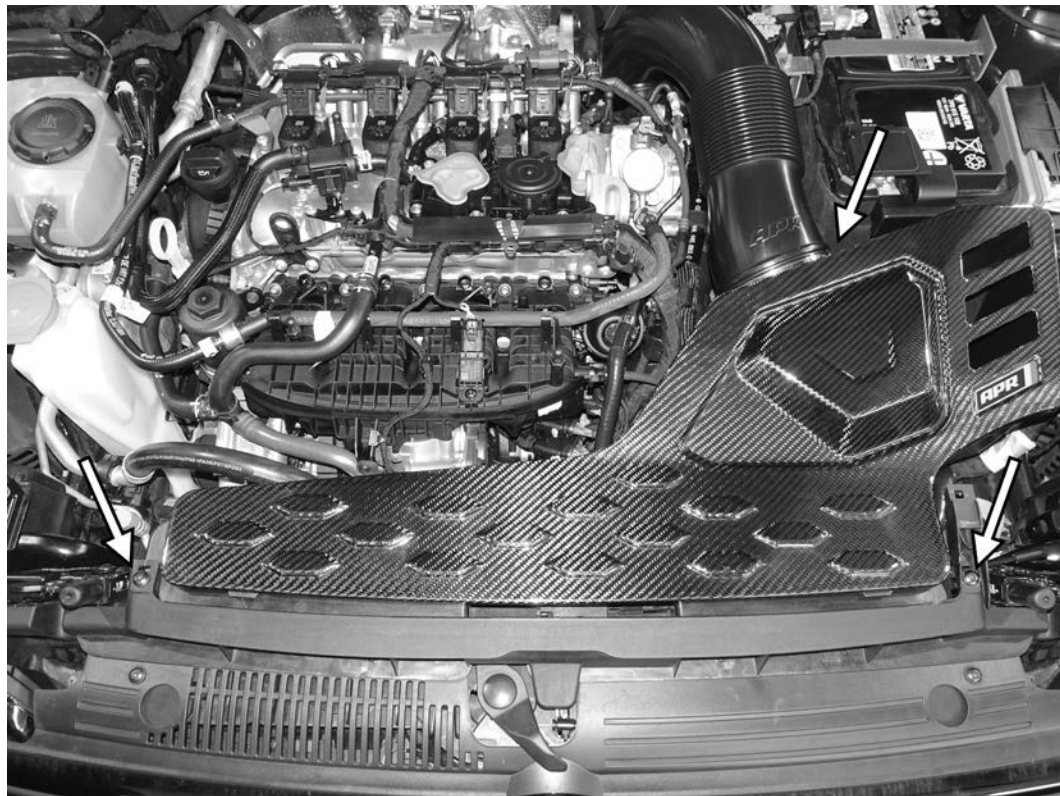

TL100191

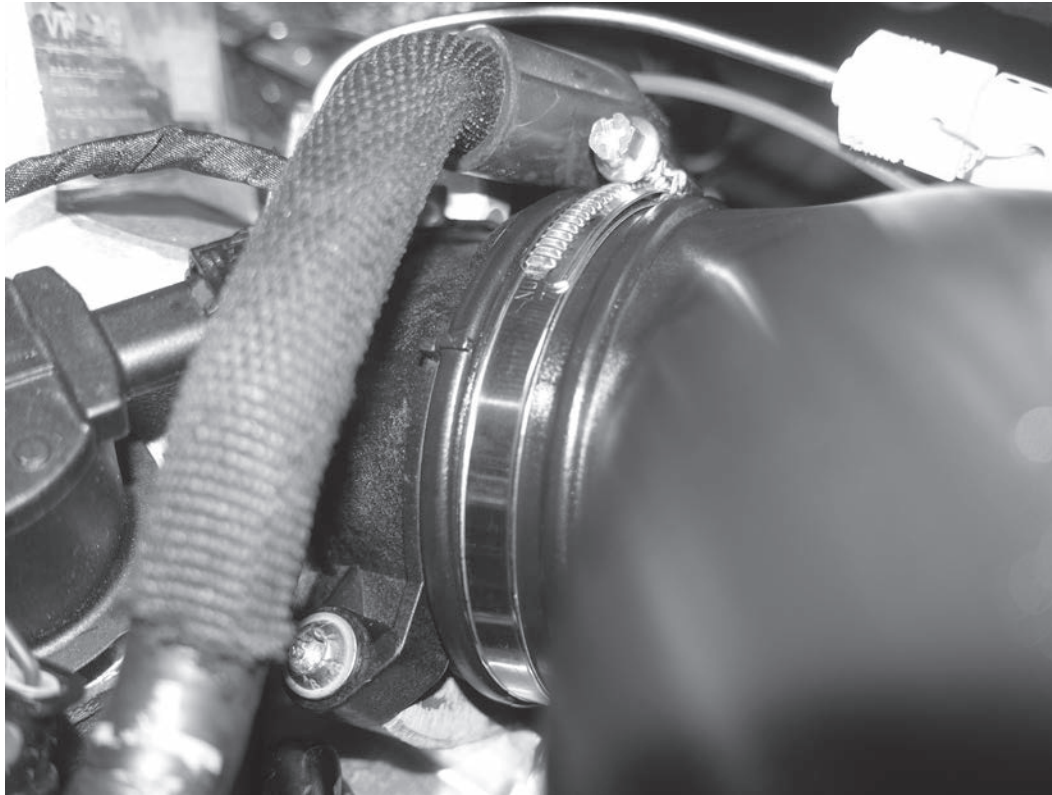

3) Loosen the 7mm clamp holding the rear intake pipe to the turbocharger inlet. Disconnect the vacuum line from the bottom of the intake pipe. Separate the pipe from the turbocharger inlet and remove it from the car.

4) Remove the T30 screw from the side of the factory turbo outlet pipe. Unhook the wiring harness from the turbo outlet pipe. Remove the 7mm hose clamp connecting the turbo outlet pipe to the turbocharger outlet coupling hose. Finally, pull the turbo outlet pipe off and away from the turbocharger. Remove the other 7mm hose clamp on the rubber turbo outlet hose and remove the hose from the turbo outlet pipe.



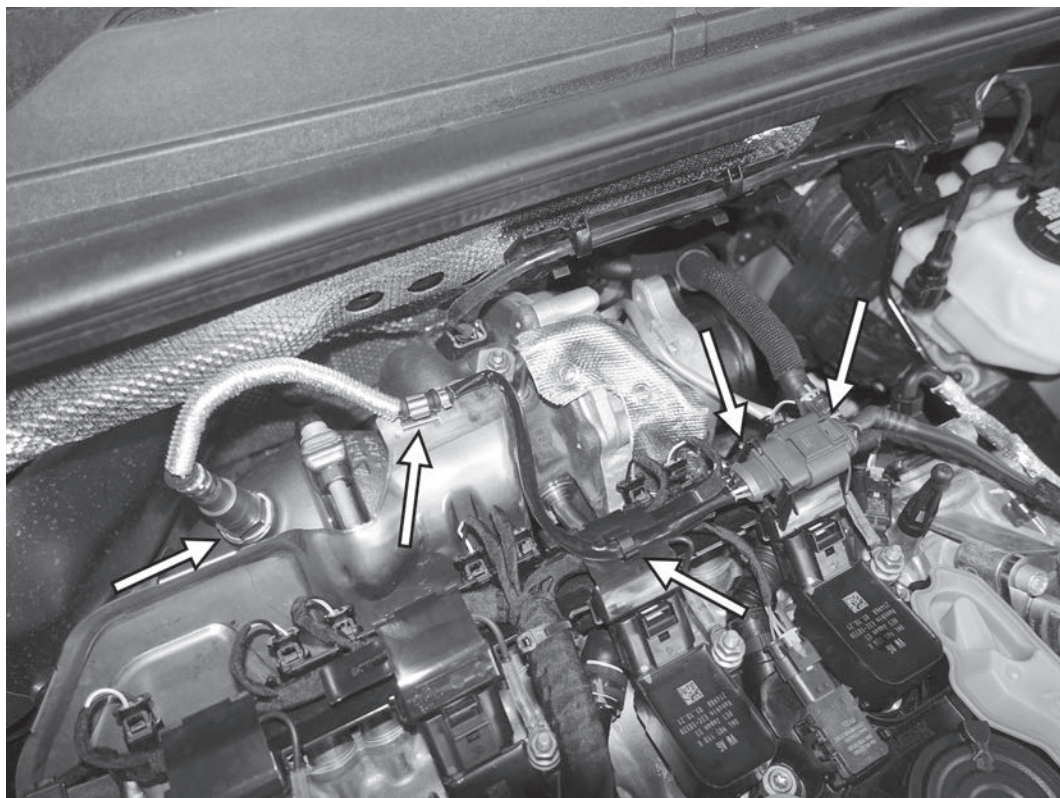

5) Disconnect the electrical connector for the primary oxygen sensor. Separate the connector from the bracket it is mounted in. Separate the harness from the two clips on top of the engine. Finally, using an oxygen sensor socket, unscrew the oxygen sensor from the downpipe to remove the sensor from the car.

6) Loosen and remove the 6mm allen screw holding the V-Band clamp on the downpipe. Separate the clamp from around the joint by prying it off.



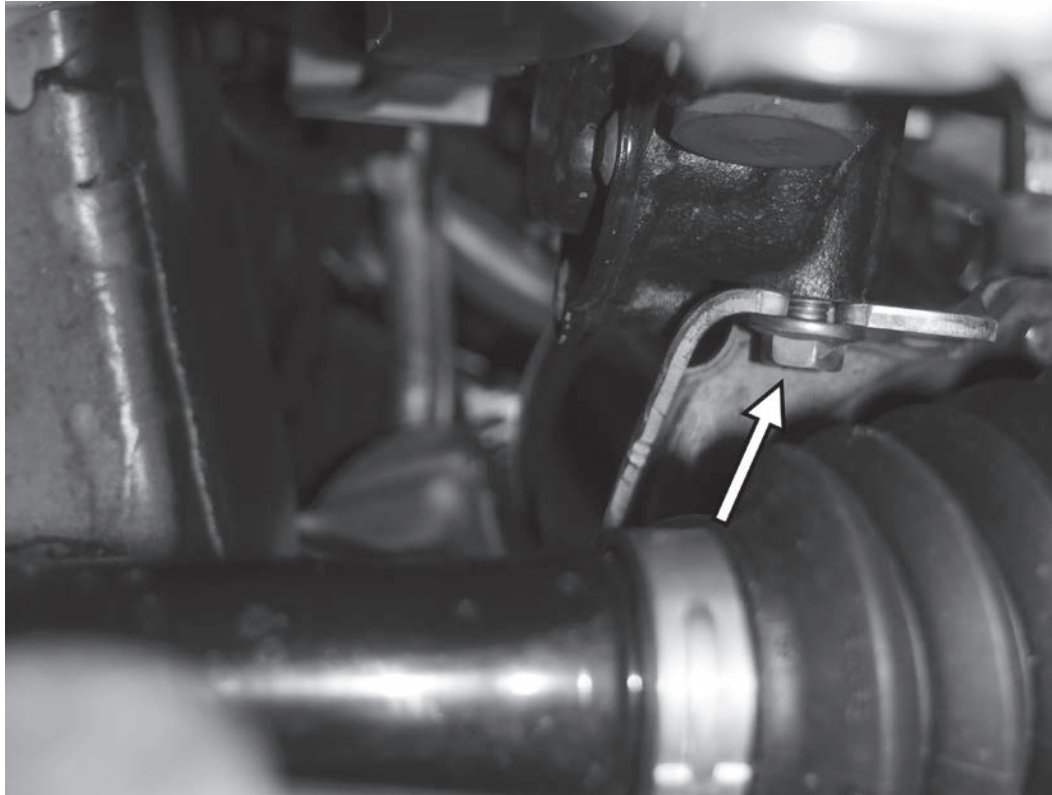

7) Remove the 13mm screw holding the downpipe bracket to the back of the engine block. As seen from below, this screw is just above the inner right CV axle joint. The downpipe can now be separated from the turbocharger and moved to the right side of the engine bay.

8) Remove the four 10mm nuts holding the grounding straps to the ignition coilpacks. Hold the studs on the ignition coilpacks with a thin 10mm wrench while loosening the four 10mm nuts. Separate the grounding straps from the mounting posts. Disconnect the electrical connectors to the PCV pressure sensor and the camshaft position sensor. Finally, disconnect the electrical connector to the diverter valve.

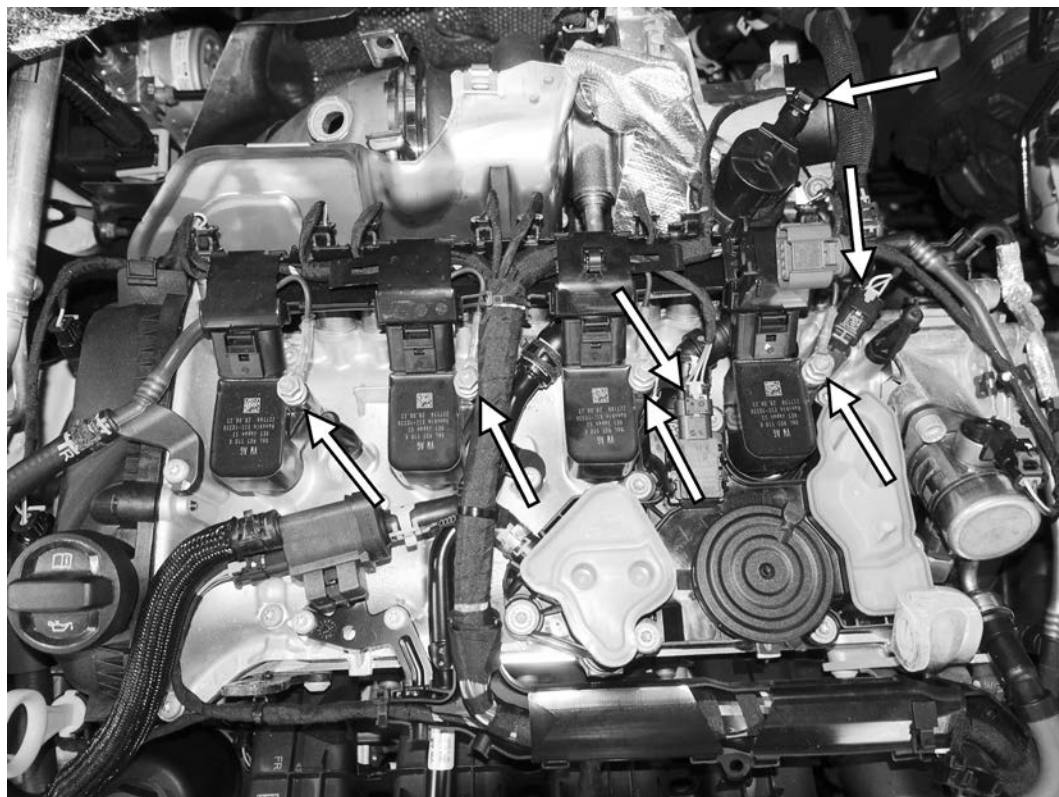

TL100191

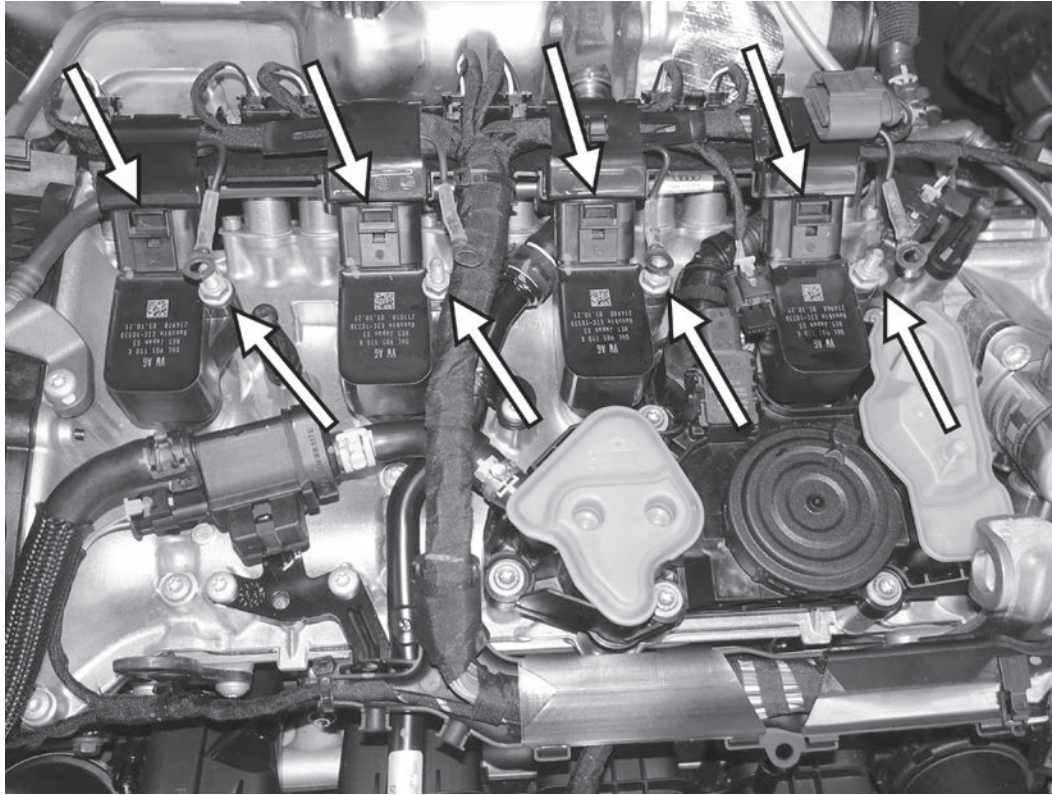

9) Remove the 10mm studs holding the coilpacks in place. Disconnect the four electrical connectors from the coilpacks, and lift the wiring harness off the coilpacks.

10) The wiring harness on the back/top of the engine now needs to be freed up. Disconnect the two electrical connectors from both cam actuators on the right side of the engine and separate the clip from the timing chain cover. Disconnect the 8 electrical connectors from the valvelift solenoids, the one on the high pressure fuel pump.



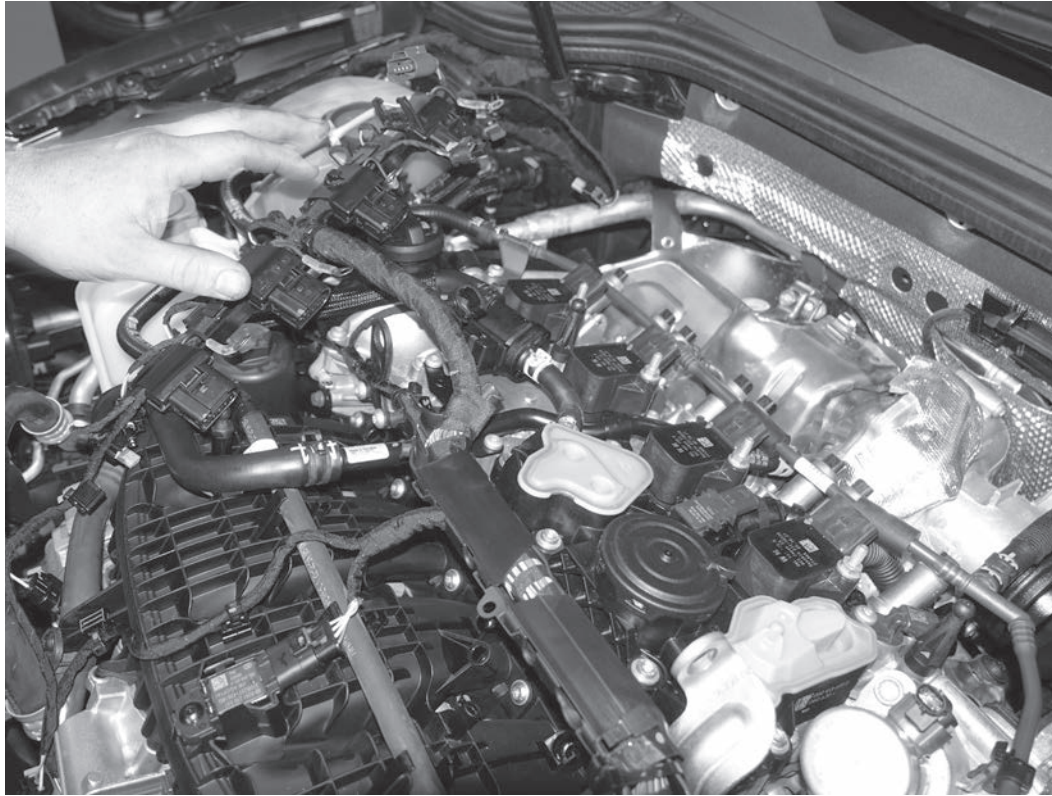

11) Lift the harness up and flip it over towards the front of the engine. Be careful to ensure that all the connections are loose as you fold the harness forward. Make sure to separate any clips holding the harness in place.

12) Remove the two T30 screws on the coolant return pipe so the line can be pulled forward later. Remove the four ignition coils at this time. If changing spark plugs, this service can be done at this point.



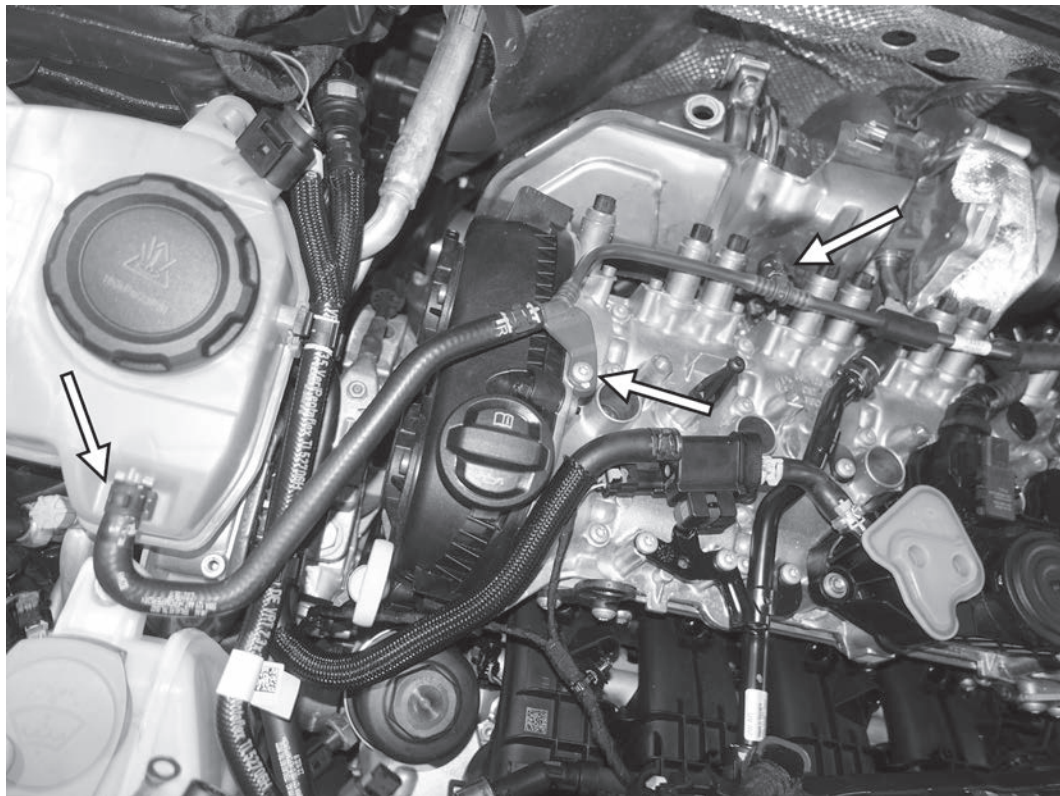

13) Disconnect the coolant line from the top of the coolant expansion tank. Remove the T30 screw holding the coolant line to the top of the valve cover. Disconnect the tee fitting on the coolant line behind the number two cylinder. Be careful not to deform the plastic coolant hose while working with it.

14) On the same coolant line, disconnect the two tee fittings behind the number four cylinder and one in front of the high pressure fuel pump. Disconnect the hard coolant line from the coolant hose that runs by the factory airbox. Finally, remove the T30 screw by the charge pipe mounting point. After ensuring everything is separated from the coolant line, remove it from the car.



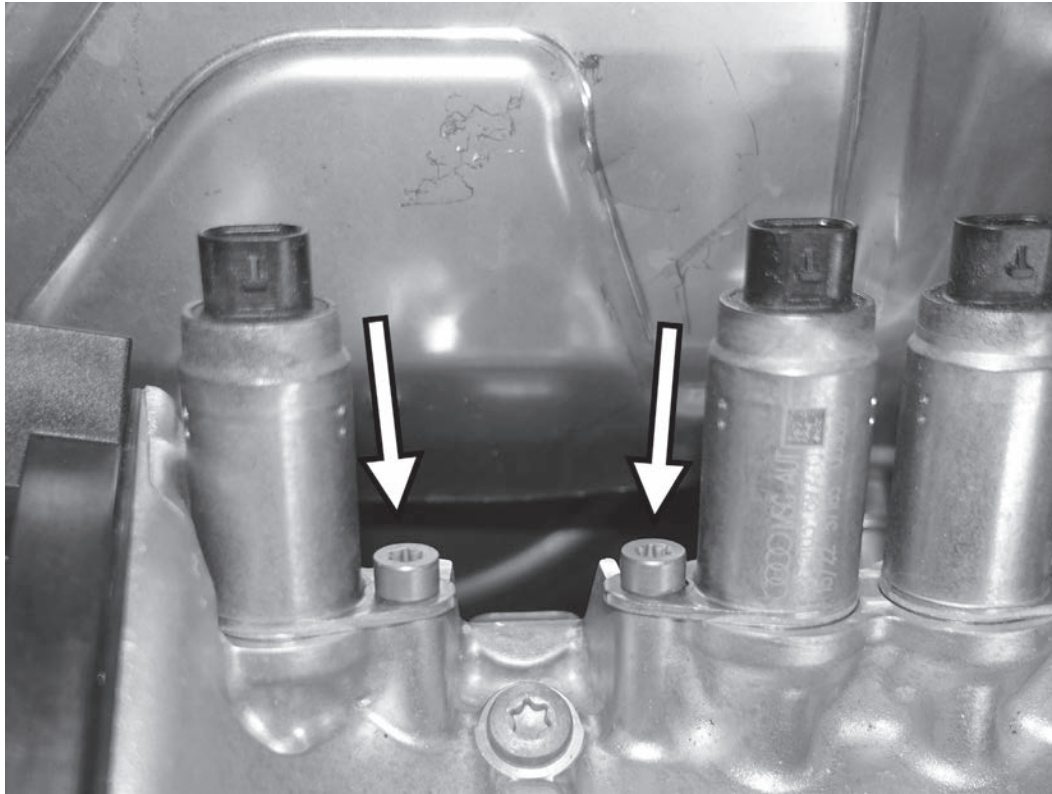

15) Remove the eight T25 screws from each of the valvelift solenoids.

16) Using a small screwdriver, carefully lift on the flange of the valvelift solenoid while twisting the solenoid to remove it from the engine. Remove all eight valvelift solenoids.

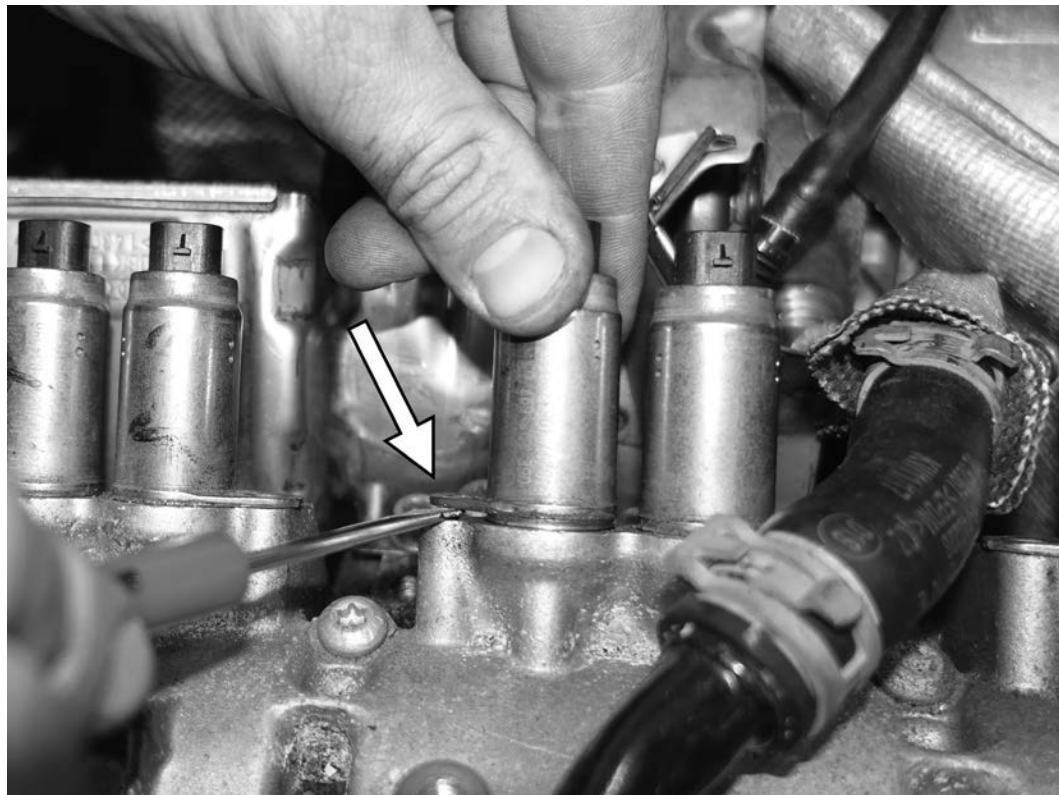

TL100191

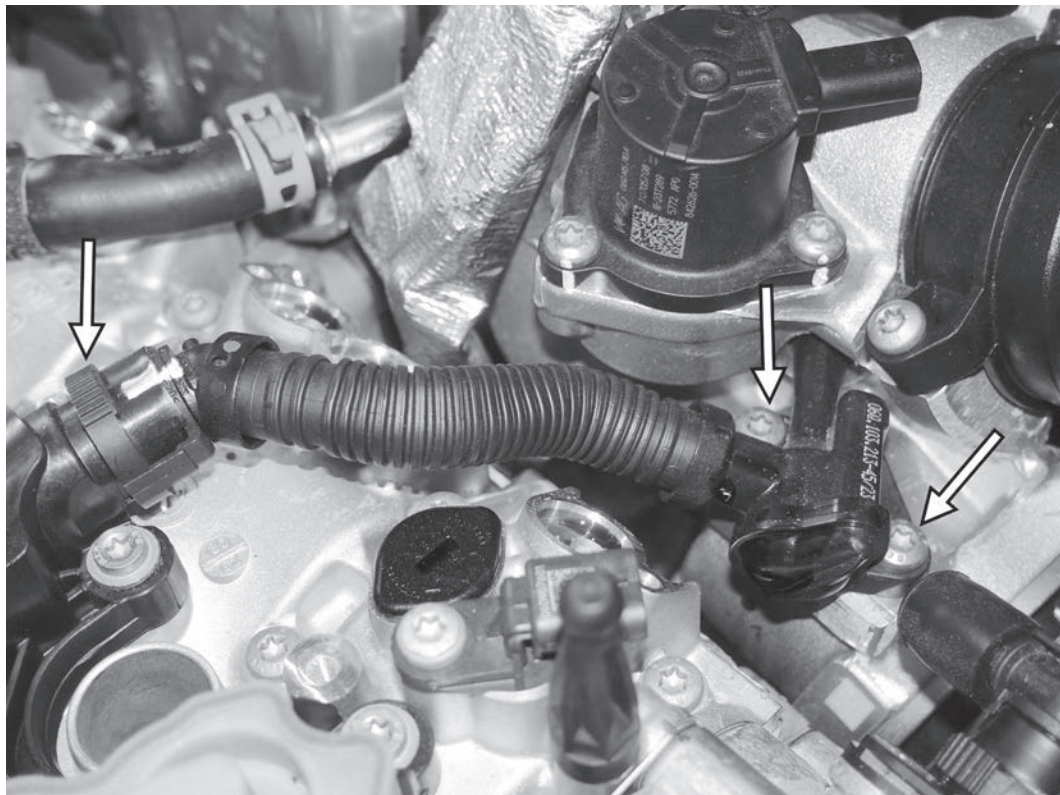

17) Remove the two T30 screws holding the suction jet into the turbo inlet. Separate the suction jet from the turbocharger. Disconnect the tube from the suction to the PCV, and remove the suction jet assembly from the car.

18) Remove the 5mm allen screw from the front left side of the turbo heat shield. While counterholding the 10mm on the bottom side of the heat shield, remove the 10mm nut from the back left side of the turbo heat shield.



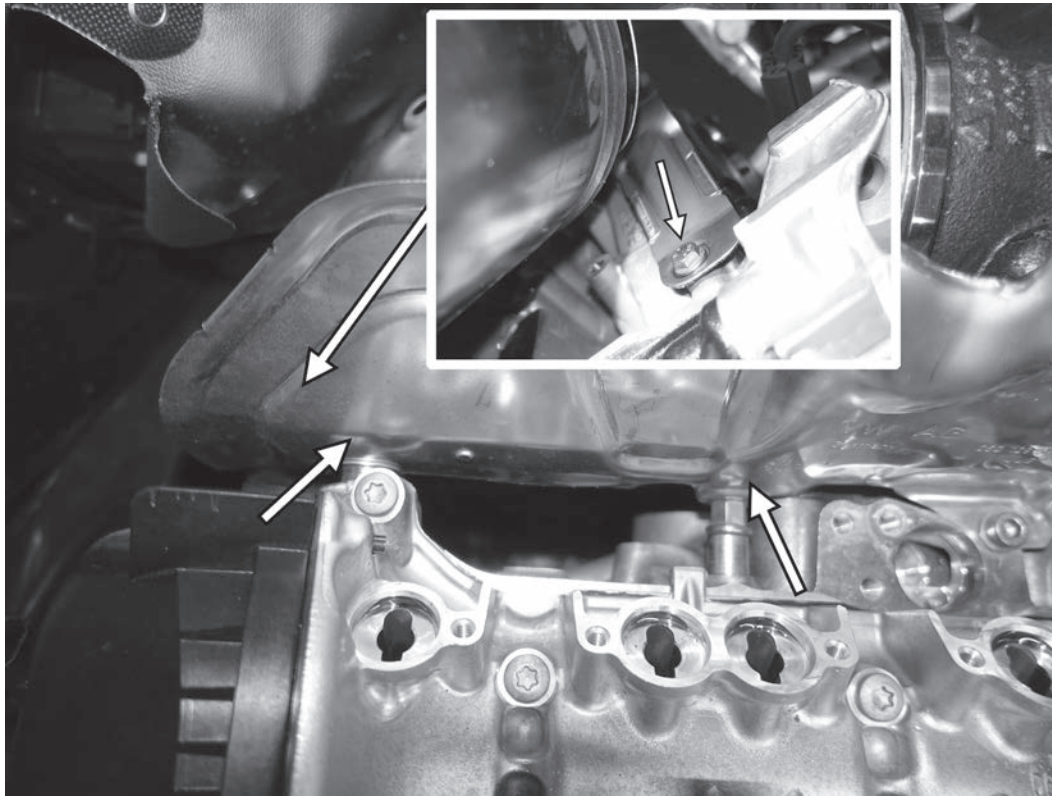

19) Remove the two 10mm nuts from the back side of the heat shield where the upper studs from the cylinder head mount the heat shield. Remove the 10mm screw (as seen from below in the inset picture) from the bottom of the heat shield. Remove the heat shield from the car.

20) Unclip the secondary oxygen sensor wiring harness from the coolant feed line on the back of the turbo. Separate the harness from the bracket on the front of the fire-wall in order to let the harness hang down low in the engine bay. Once removed, unscrew the 8mm triple square screw holding the coolant line to the turbo. Separate the coolant feed line from the turbo.

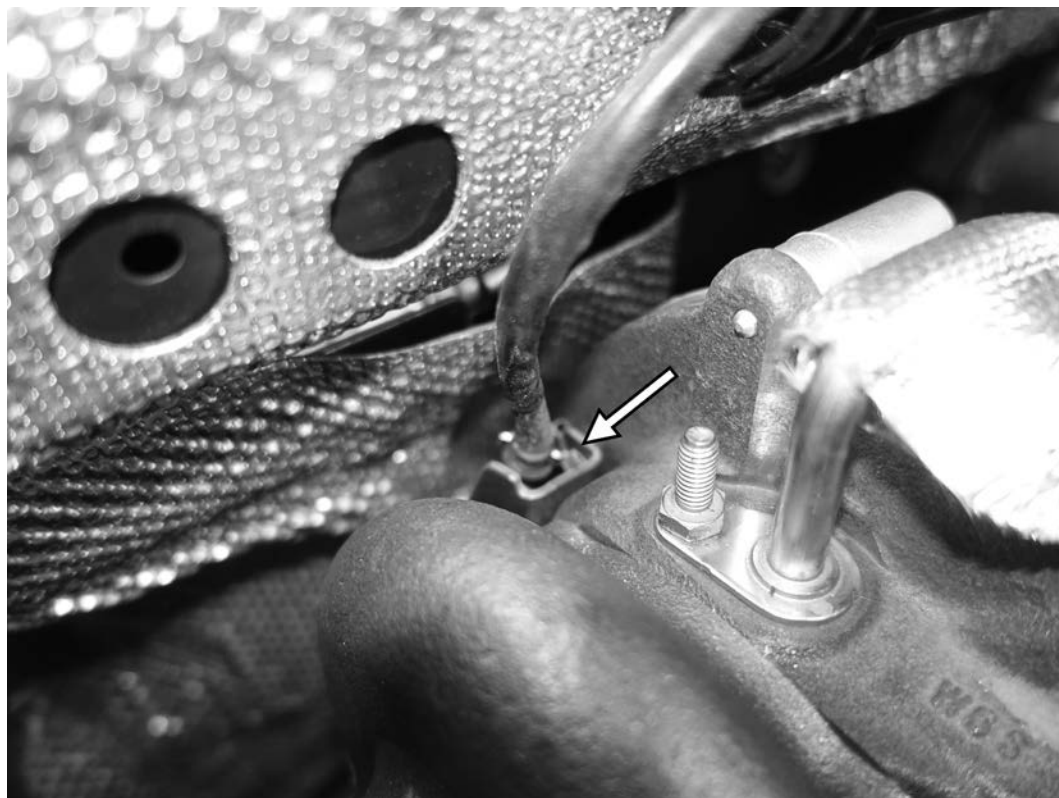

TL100191

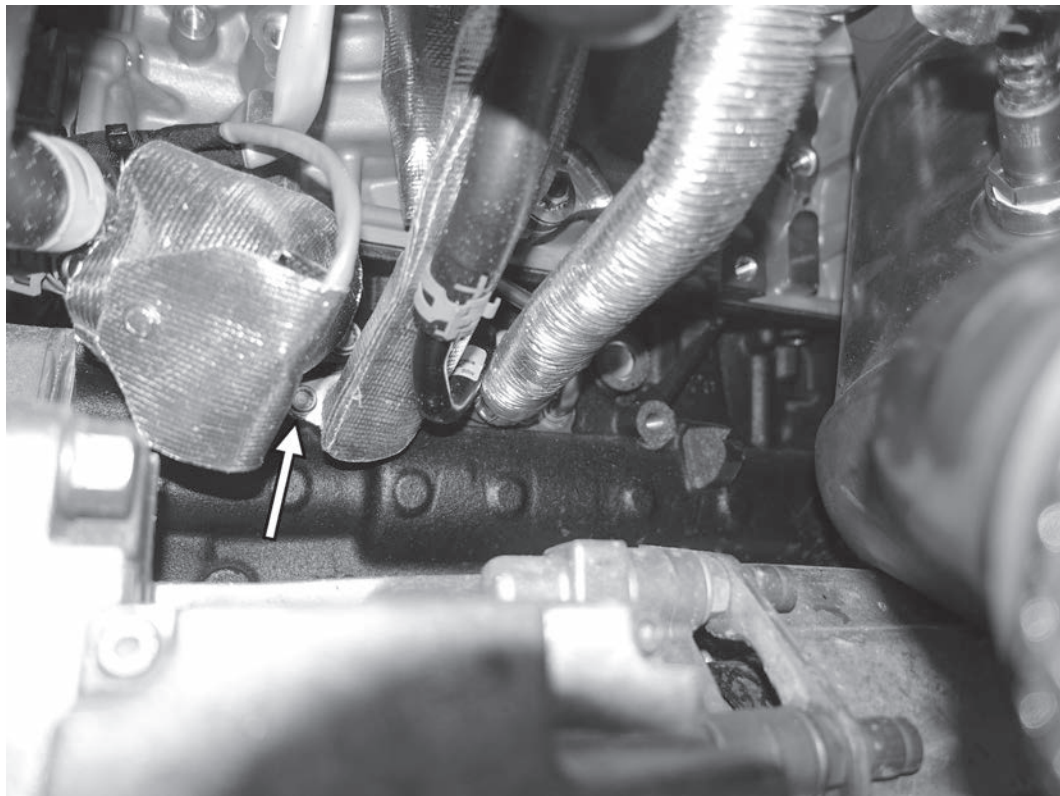

21) As pictured from behind the engine, follow the oil drain line from the bottom of the turbo down to where it connects to the engine block. Remove the 8mm triple square screw and separate the line from the engine block.

22) Remove the 10mm threaded stud on the oil feed line at the top of the turbo, as well as the 8mm triple square screw on the coolant return line on the front of the turbo. Separate the coolant return line from the turbocharger. The coolant return line should be freed up from the valve cover to move the line forward and out of the way.



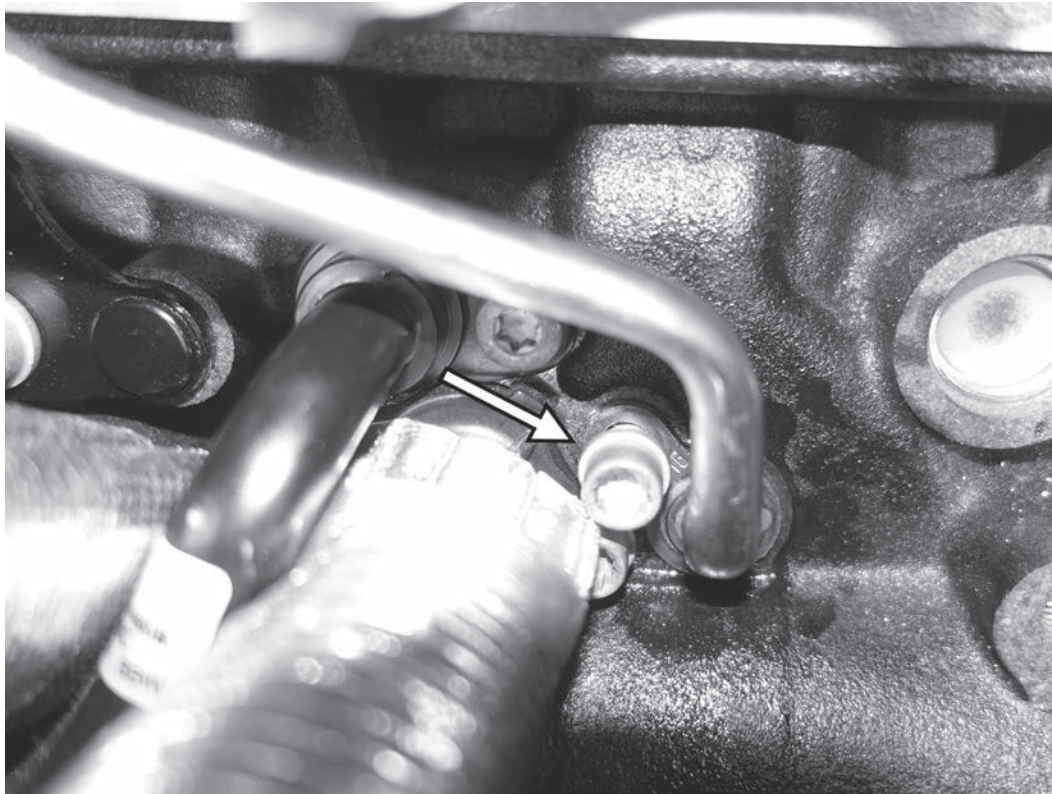

23) Follow the oil feed line to where it attaches to the back of the engine block. Remove the 8mm triple square screw holding the feed line to the engine block. Separate the feed line from the block and then remove the oil feed line from the car.

24) Remove the two turbo nut straps holding the four nuts holding the turbocharger to the cylinder head. Use a screwdriver, chisel, or prybar to pop them off from the nuts.

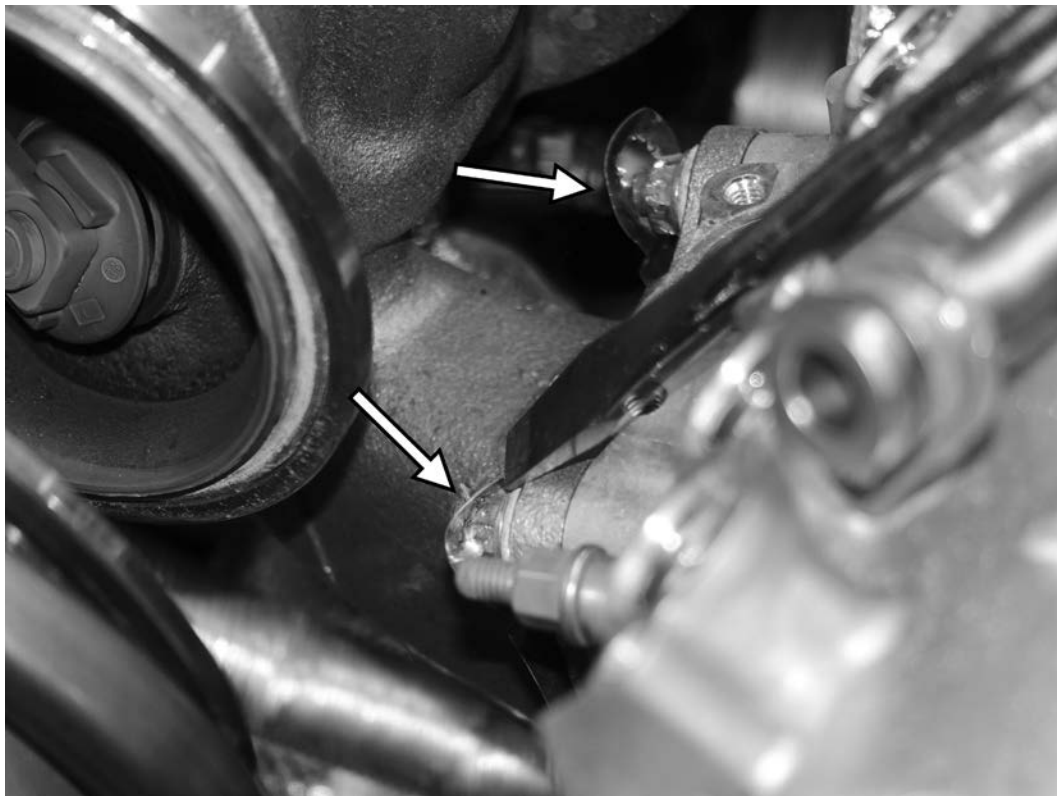

TL100191

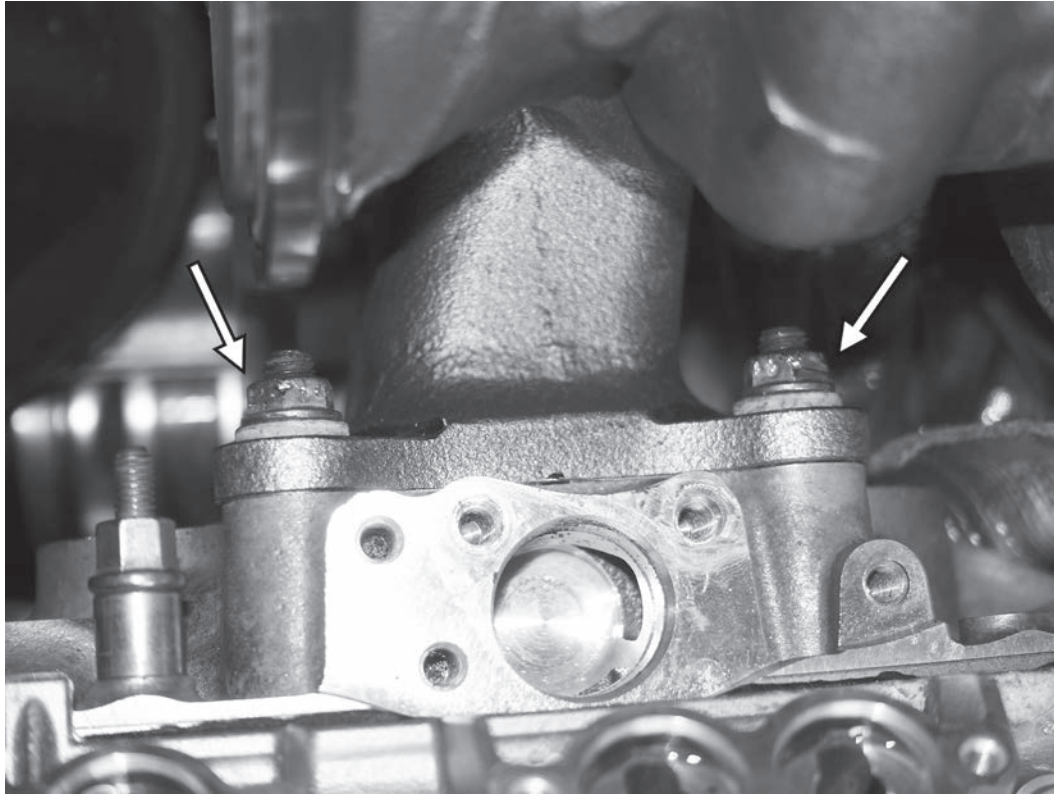

25) Remove the four 12mm nuts holding the turbocharger to the cylinder head.

26) Slide the turbocharger backwards on the studs on the cylinder head. Disconnect the wiring harness to the wastegate by first sliding back the locking tab on the connector, and then squeezing the connector to separate it from the wastegate. Inspect around the turbo to ensure all lines have been disconnected from it. The oil drain line is the only hose that should still be attached to the bottom of the turbo, but should be disconnected from the engine block.



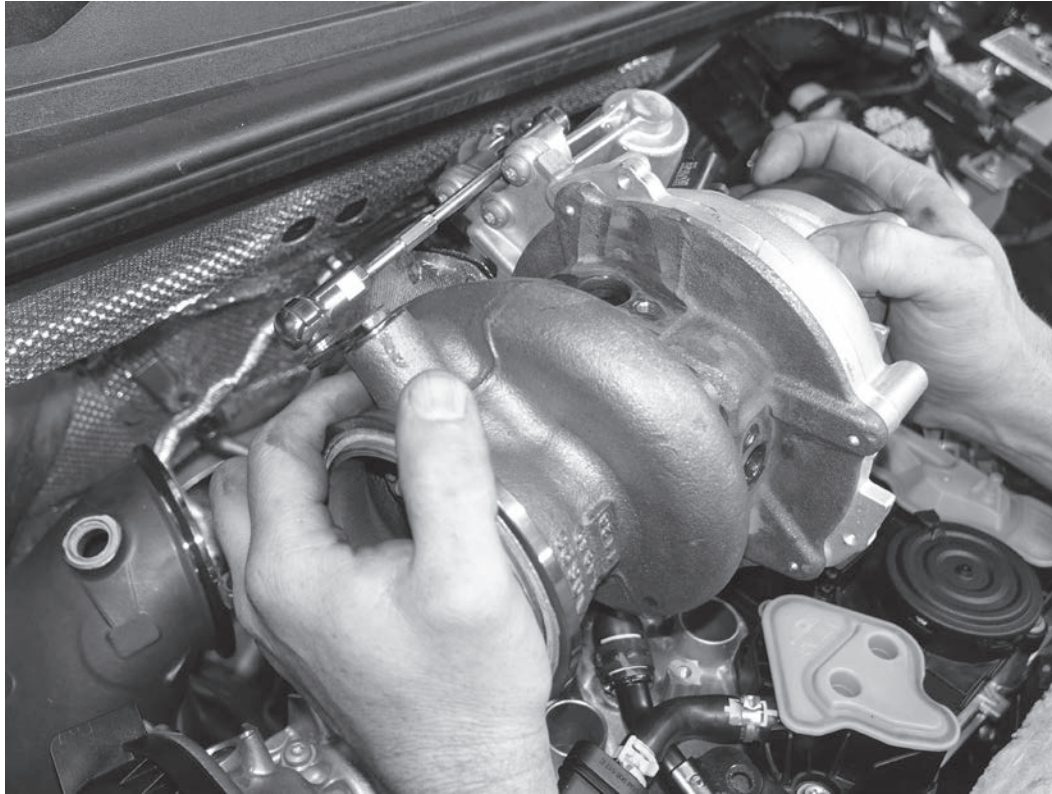

27) Carefully lift and rotate the turbocharger up and out of the engine bay, making sure not to snag or hit the turbo on anything while removing it.

28) With the turbo off the car, remove the 8mm triple square screw holding the oil drain line to the bottom of the turbo, and separate the line from the turbo.

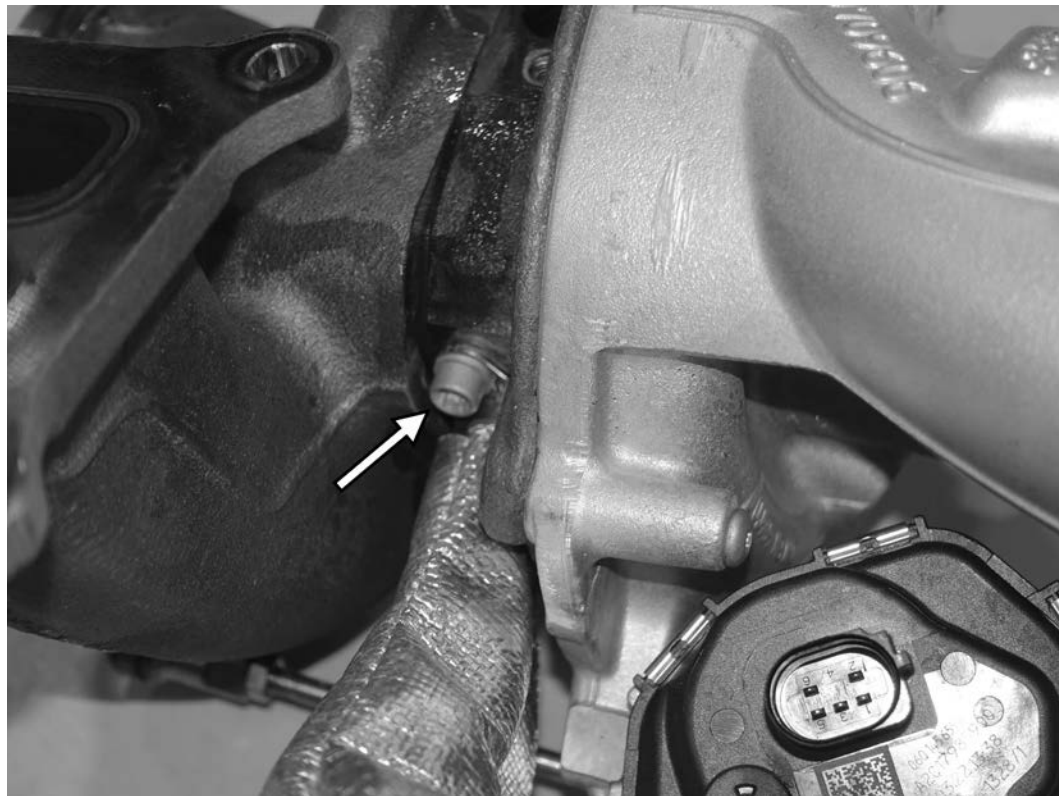

TL100191

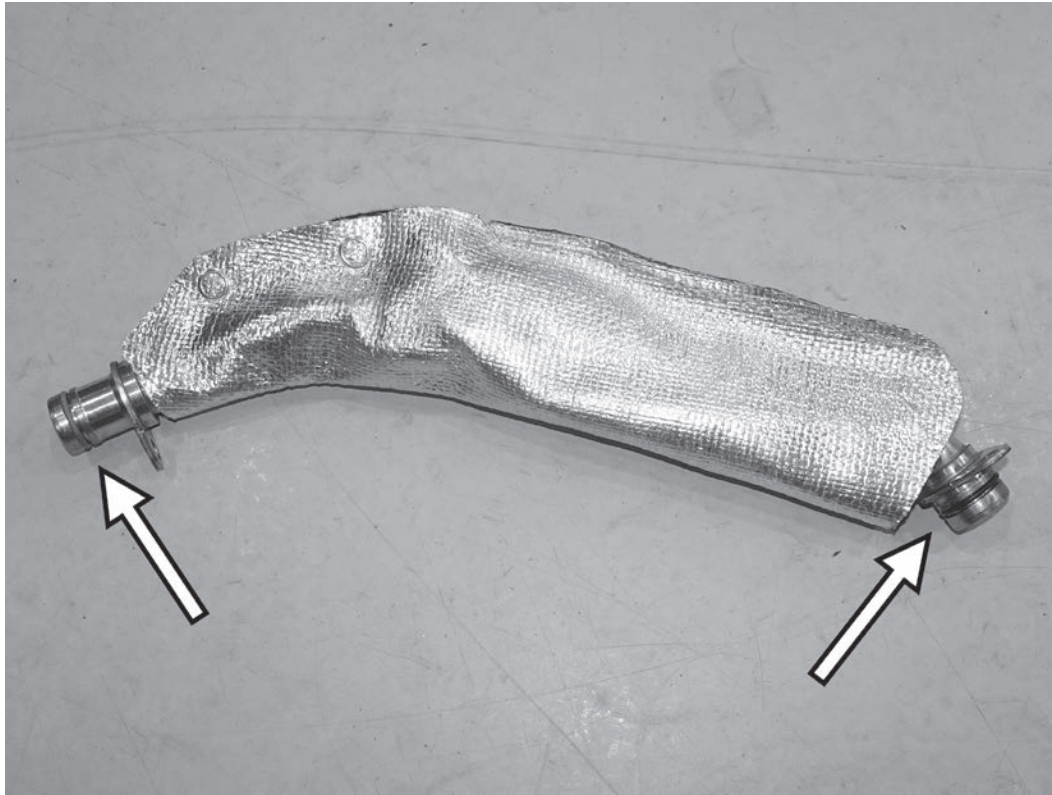

29) Replace the o-ring on the upper side of the oil drain line (the smaller end) with the supplied 15x1.8mm o-ring. This is usually green or red in color. Replace the o-ring on the lower side of the oil drain line with the supplied 16.75x1.65mm o-ring. This is the largest diameter o-ring in the kit.

30) On the oil feed line previously removed from the car, unsnap the cloth heatshield from the oil feed line. Cut a notch in the back side of the heat shield, approximately by the third snap. The new oil feed line (from the Golf R) has a mounting tab for a screw that attaches the line to the turbo. Install the heat shield over the new oil feed line. The new oil feed line should come with new o-rings on both ends of the line.

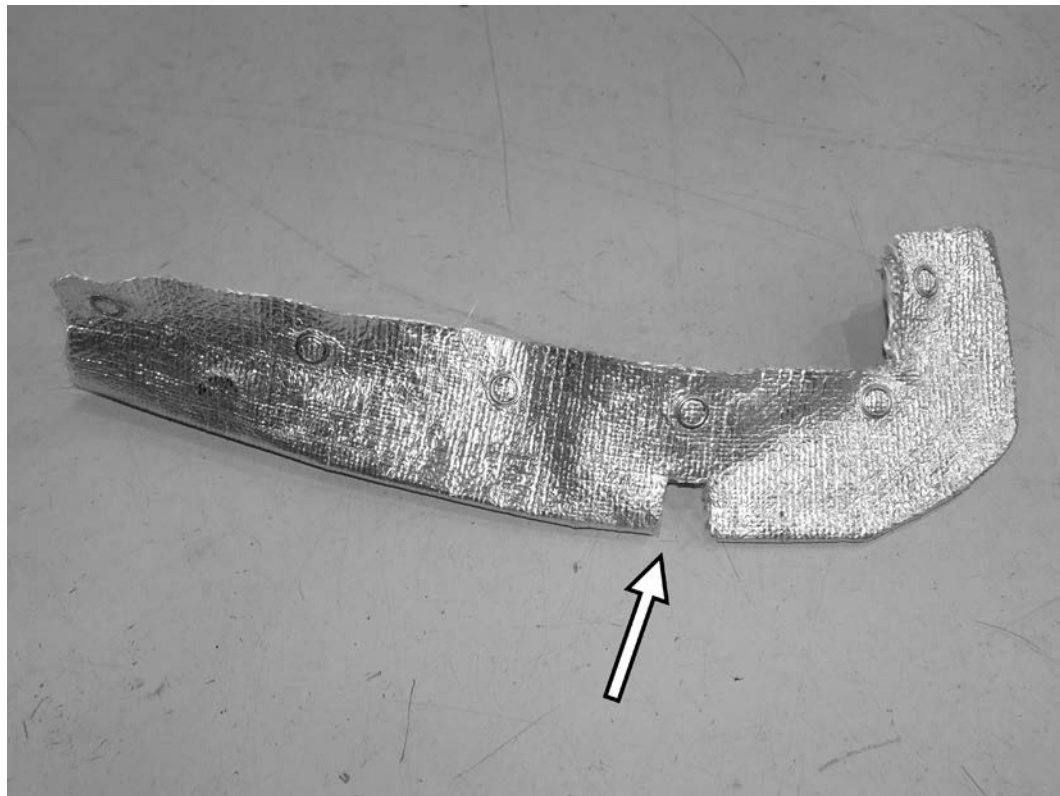

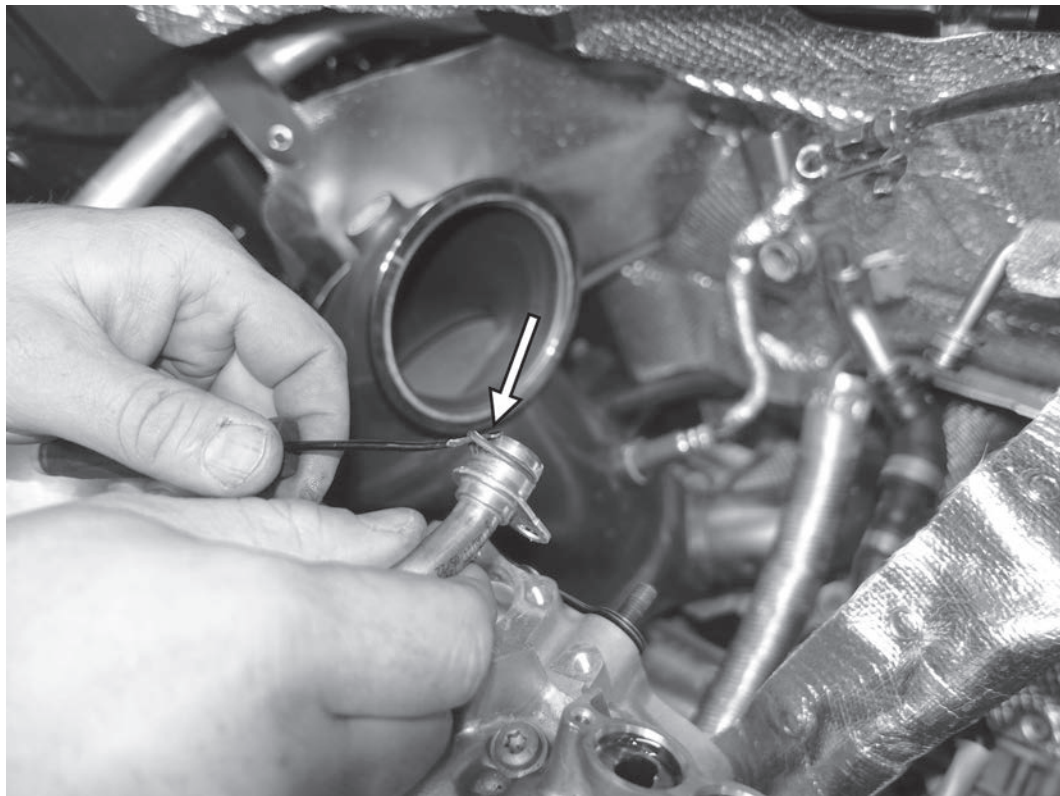

31) On the coolant return line still on the car, replace the o-ring with one of the supplied 15x2mm o-rings. There are two o-rings of this size supplied in the kit.

32) On the coolant feed line still on the car, replace the o-ring with the second supplied 15x2mm o-ring. This is the last o-ring supplied in the kit.



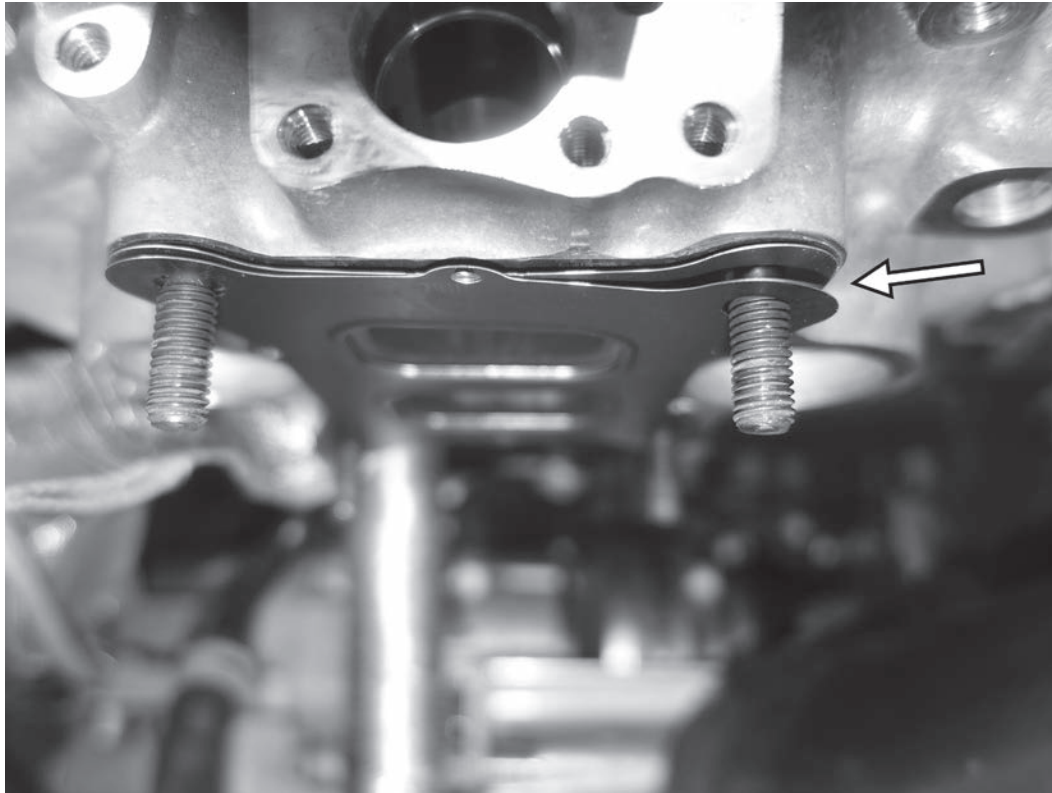

33) Remove the old turbo to cylinder head gasket. Clean the mating surface of the cylinder head and then install the new supplied gasket on the studs on the cylinder head.

34) Install the supplied v-band gasket into the groove on the turbine outlet side of the new turbo.

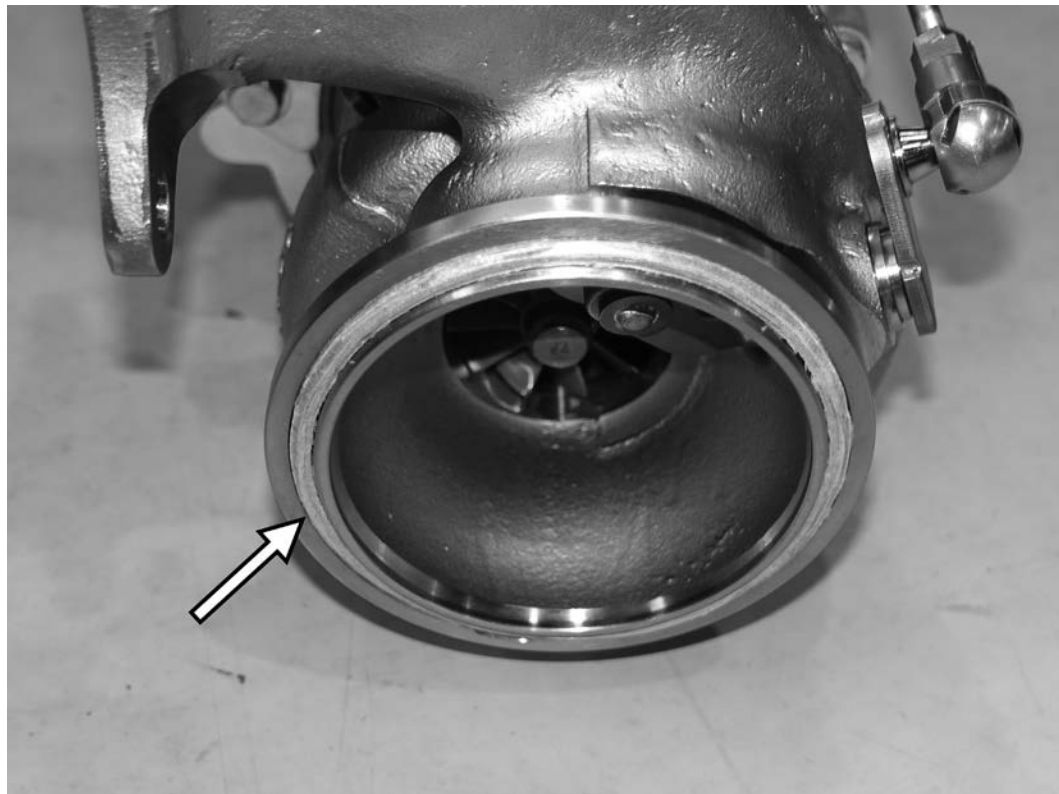

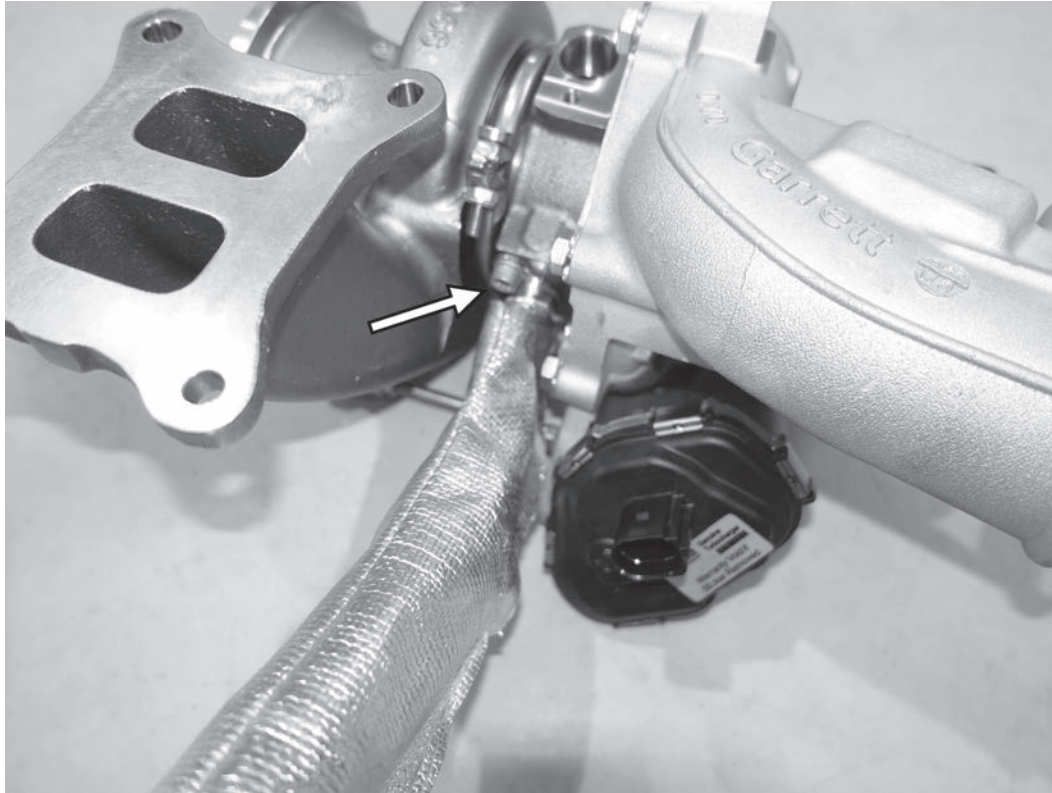

35) Install the oil drain line into the bottom of the new turbo. Secure the line with the original 8mm triple square screw to 9Nm (80 in-lbs).

36) Install the new oil feed line in the car, securing the line to the block with the original 8mm triple square screw. Tighten the screw to 9Nm (80 in-lbs).



TL100191

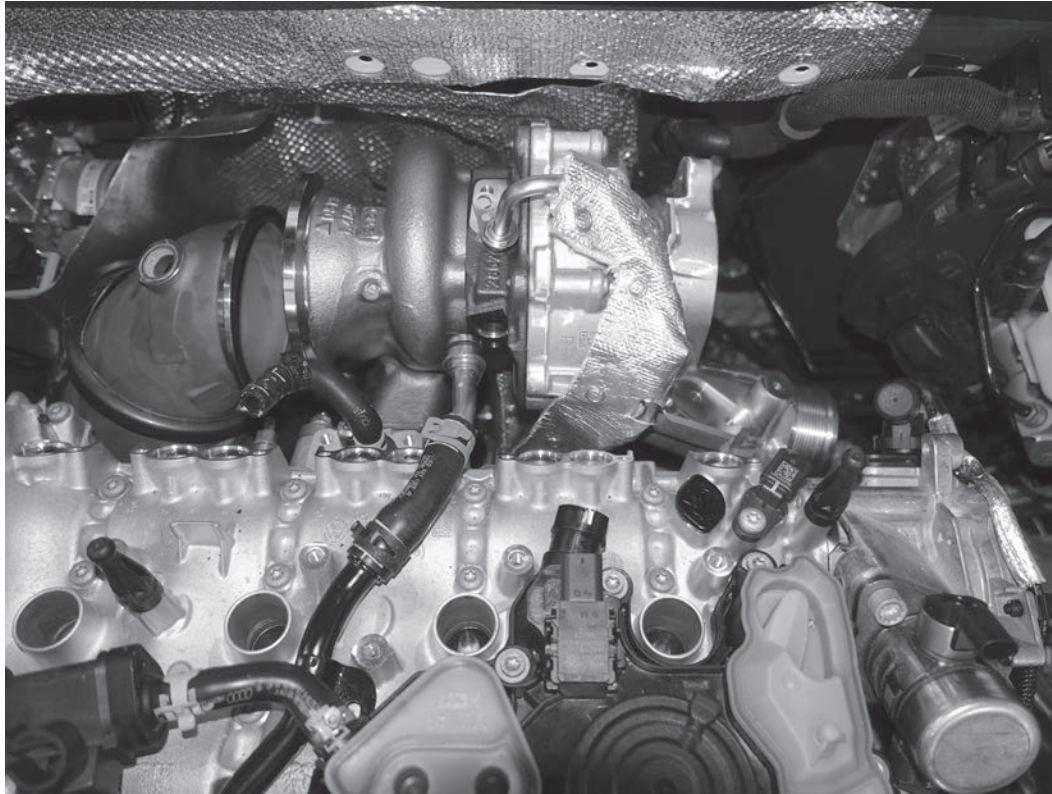

37) Carefully lower the new turbo into place in the car, placing the turbo on the studs on the back of the cylinder head. Make sure the oil feed line routes between the turbo and the cylinder head. Make sure the oil drain line properly routes down and goes into its connection on the back of the engine block. The drain line does not need to be fully installed, but does need to be routed correctly. Reconnect the electrical connector to the electronic wastegate solenoid and secure with the locking tab on the connector.

38) Install the four supplied 12mm nuts to hold the turbo in place. Tighten all four nuts hand tight in a circular pattern (top left, top right, bottom right, bottom left). Then, tighten the nuts in the same pattern to 10Nm (88 in-lbs). Finally, tighten all four in the same pattern to 25Nm (221 in-lbs).

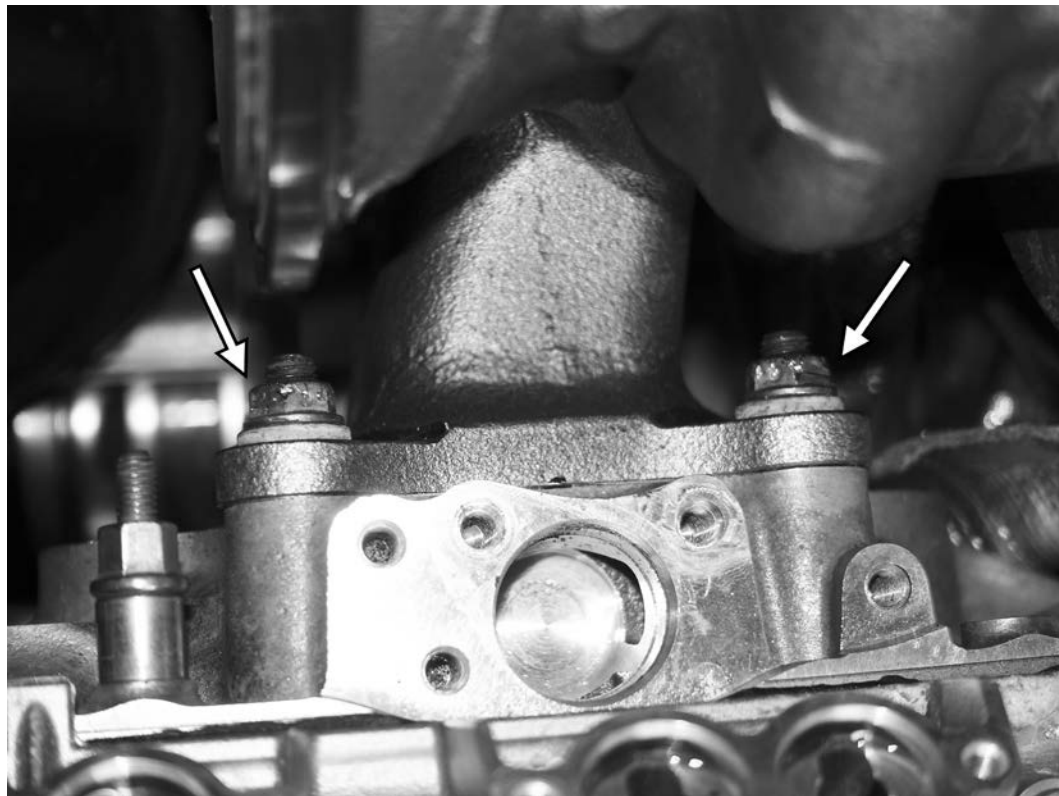

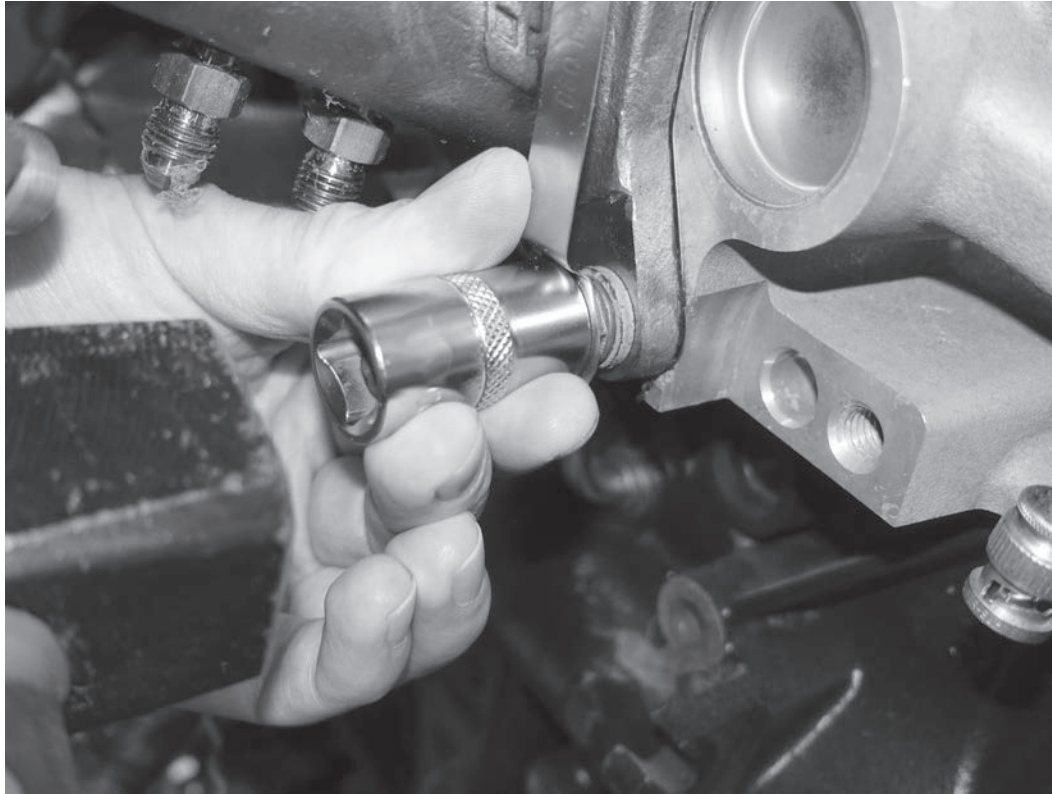

39) Install the two turbo nut straps to secure the nuts in place. Use a 14mm socket to hammer the lower side of the strap in place, before doing the same to hold the upper side of the strap in place. Consequently, you can also use a 14mm wrench with a pry bar to “press” the straps in place.

40) Secure the oil feed line to the front of the compressor housing with the new 8mm triple square screw. Tighten the screw to 9Nm (80 in-lbs).

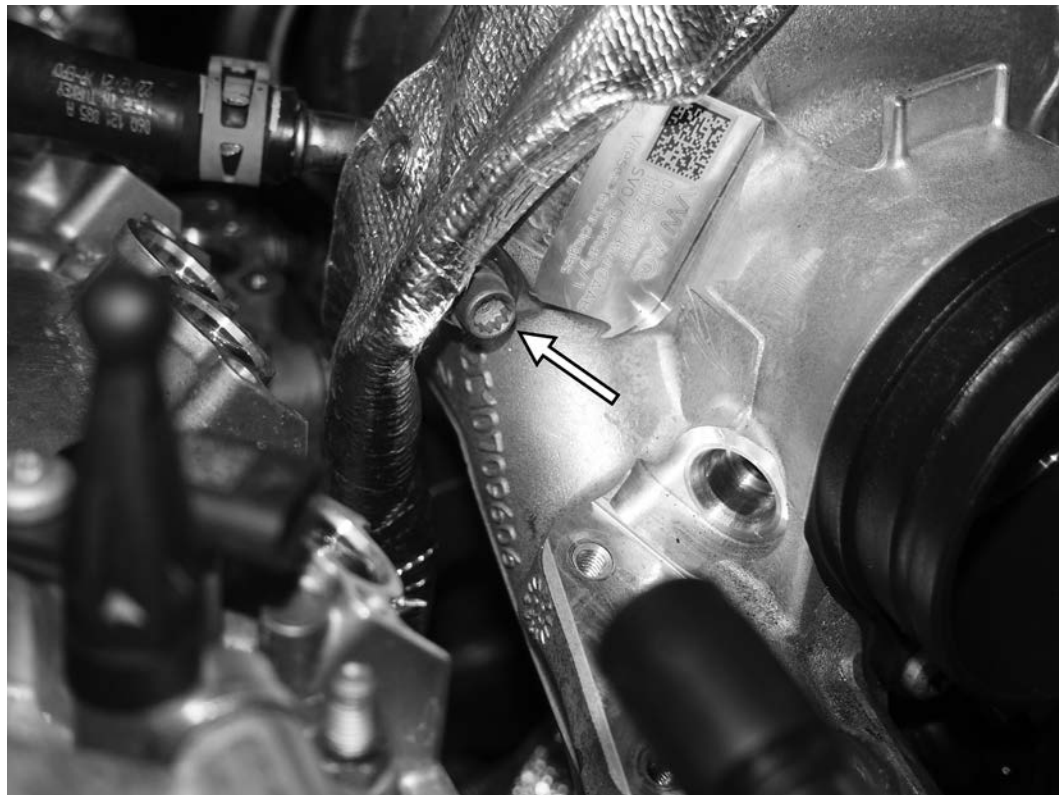

TL100191

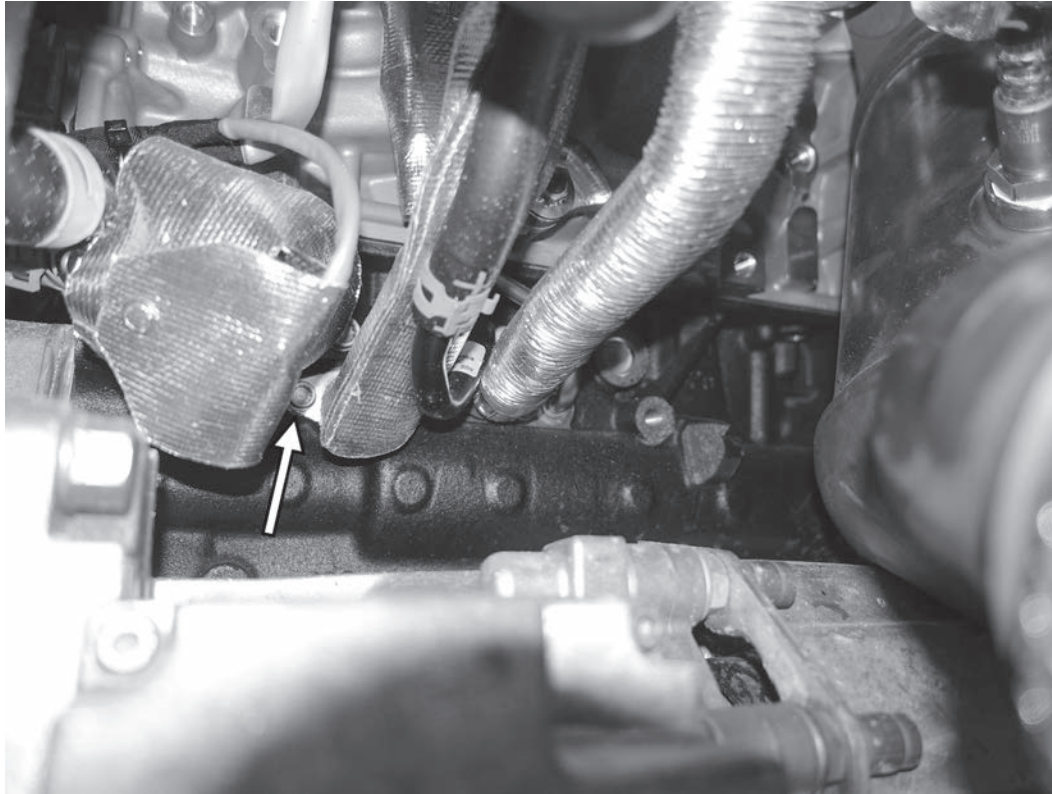

41) Reinstall the oil drain line into the hole on the side of the engine block, and secure the drain line with the original 8mm triple square screw. Tighten the screw to 9Nm (80 in-lbs).

42) Fill the turbocharger at the oil feed line with clean engine oil, and then install the oil feed line into the top of the turbo. Secure with the original 10mm threaded stud and secure it to 9Nm (80 in-lbs). Install the coolant return line into the front of the turbo and secure it with its original 8mm triple square screw, tightening it to 9Nm (80 in-lbs).



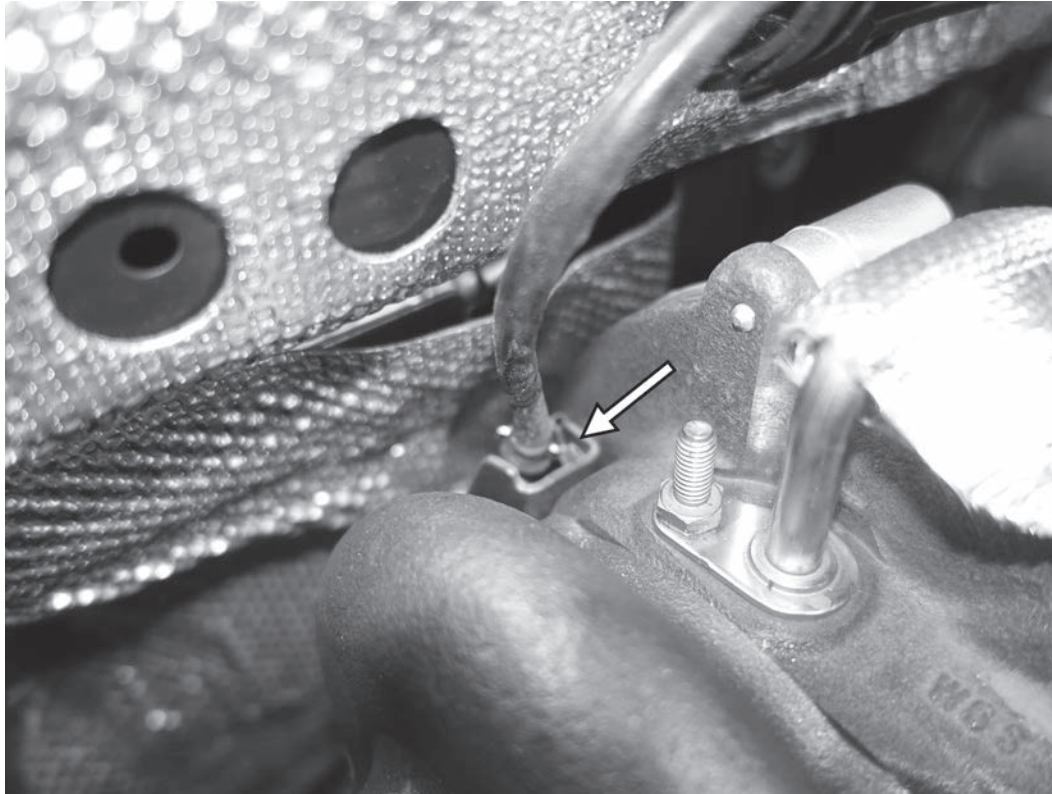

43) Press the coolant feed line into the back of the turbo and secure it with its original 8mm triple square screw, tightening it to 9Nm (80 in-lbs). Reclip the wiring harness for the secondary oxygen sensor to the back of the coolant feed line, and then reroute and resecure the harness into the bracket on the front side of the firewall.

44) Reinstall the heat shield on the studs that protrude from the back of the cylinder head. Secure with the three 10mm nuts that originally held it in place and tighten the nuts to 8Nm (71 in-lbs).

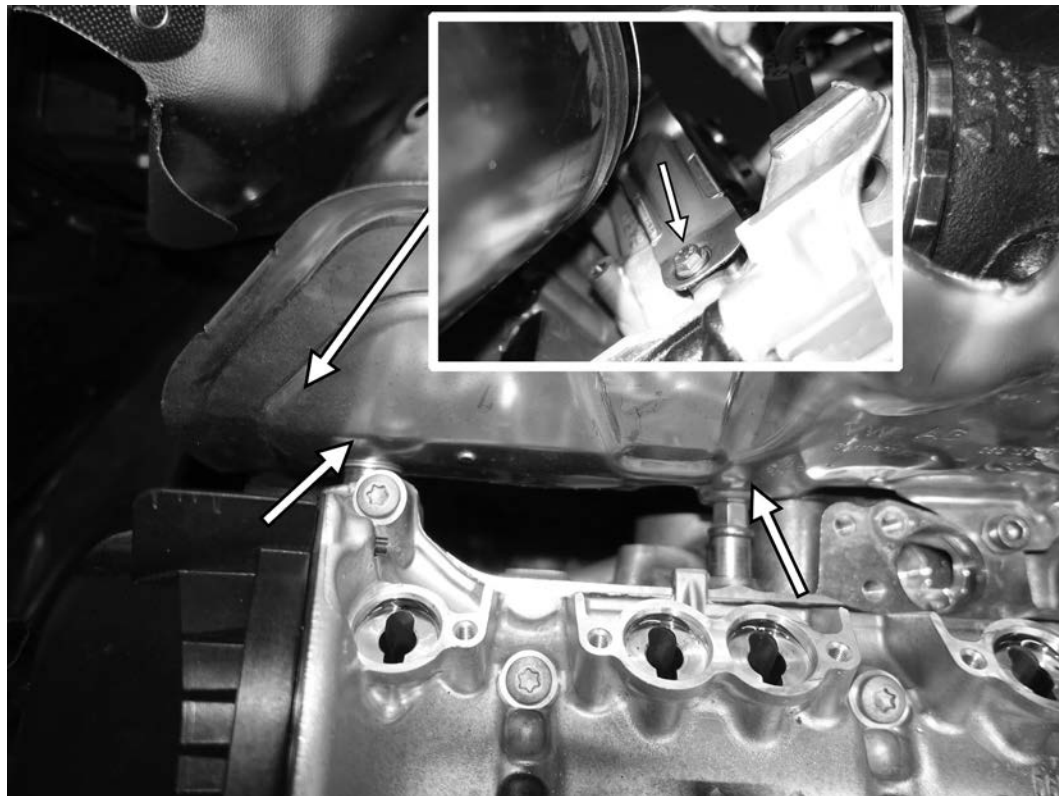

TL100191

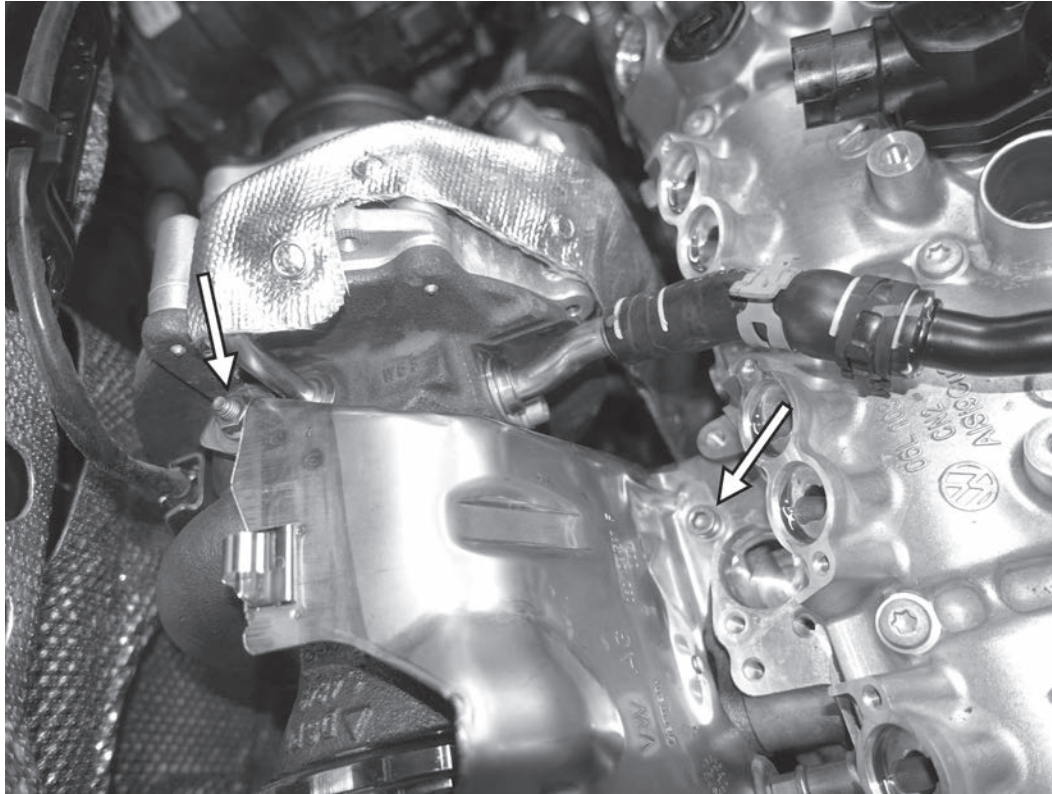

45) Reinstall the 5mm allen screw on the front side of the heat shield and secure to 8Nm (71 in-lbs). Install the 10mm nut on the threaded stud for the oil feed line and secure the nut to 8Nm (71 in-lbs).

46) Remove the T30 screw from the back left corner of the cam cage/valve cover.

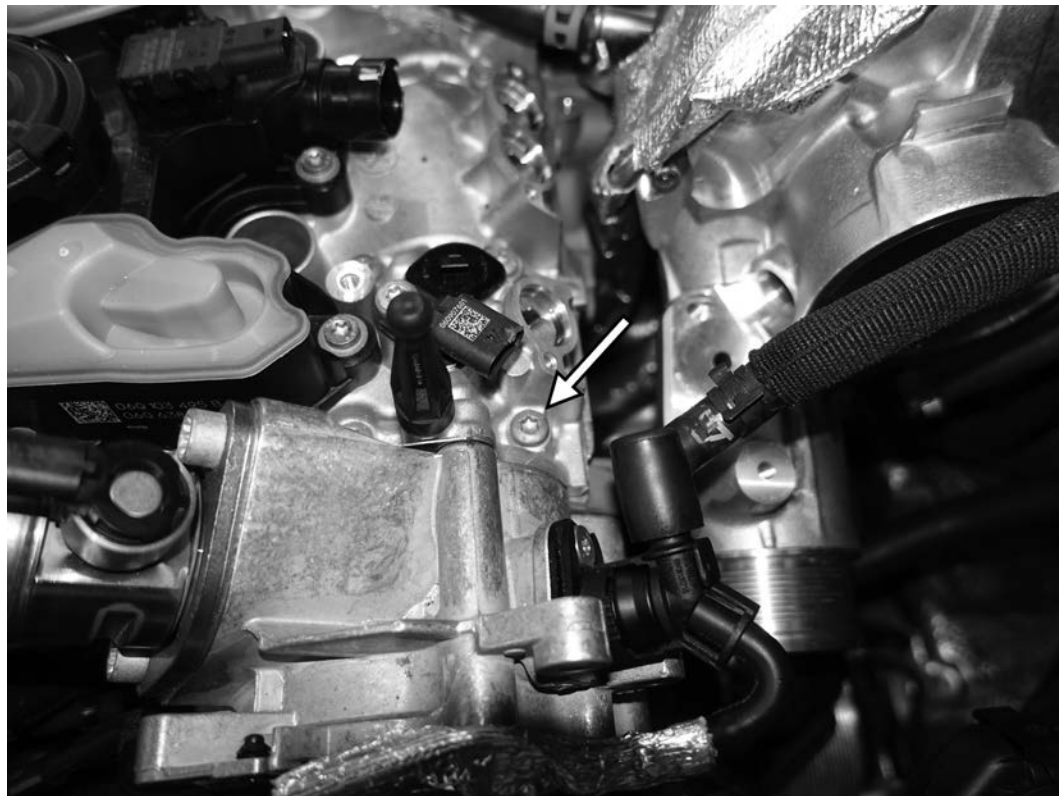

TL100191

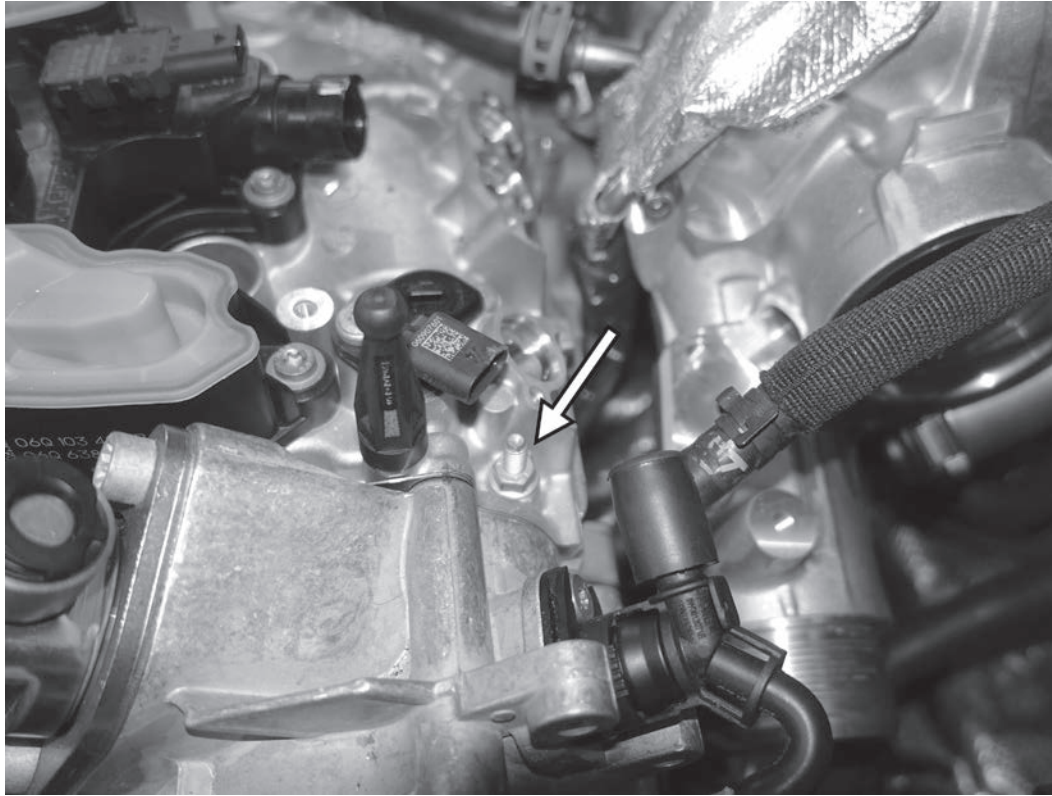

47) Install the new threaded stud into the hole the T30 screw was removed from. Tighten the stud with a deep well 10mm socket to 8Nm (71 in-lbs). Then tighten the stud an additional 90°.

APR

48) Install the turbo support brace on the compressor side of the turbo. Install the two T30 screws and one 10mm nut, tightening all fasteners to 9Nm (80 in-lbs).

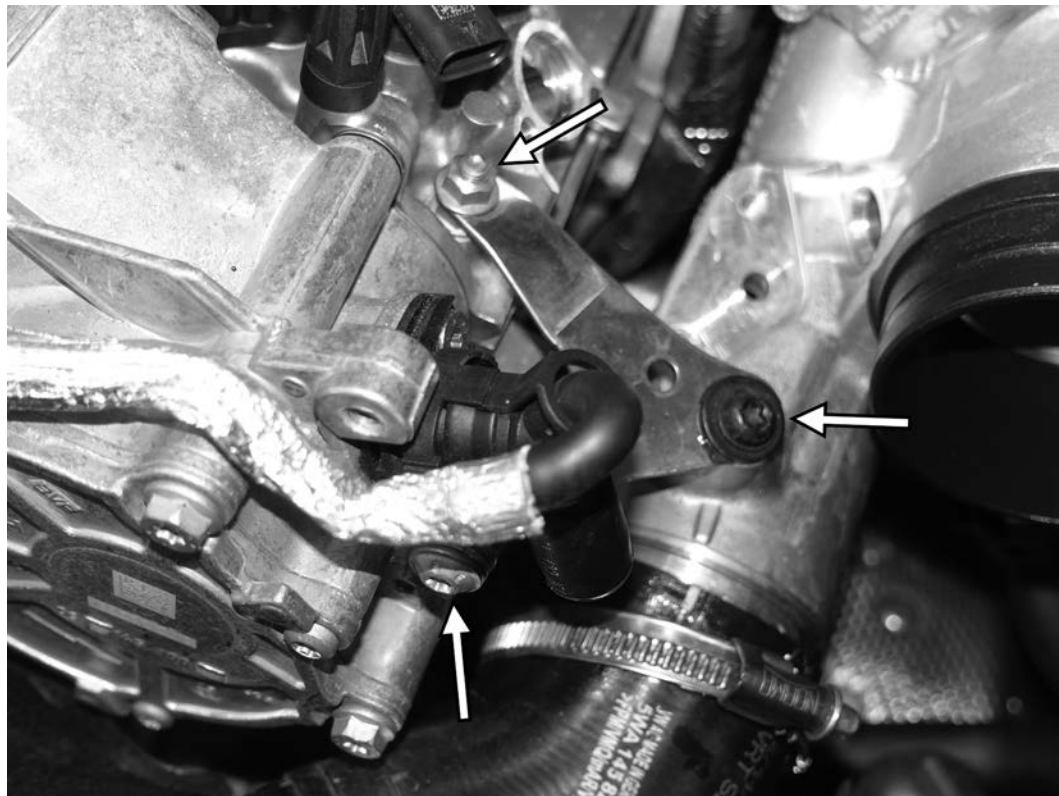

TL100191

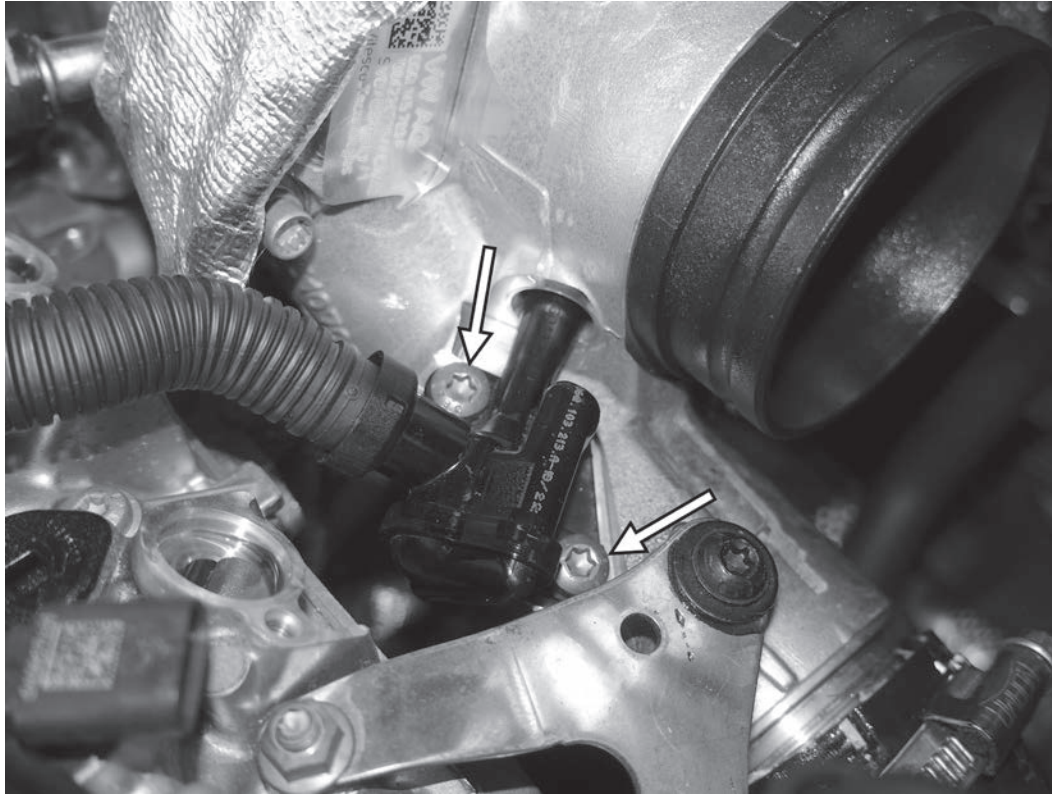

49) Reconnect the suction jet tube to the connection on the PCV, then lower the suction jet into place on the turbo. Secure with the two original T30 screws and tighten to 9Nm.

50) Reinstall all eight valvelift solenoids into the cylinder head. The pin on the bottom of the solenoid should be retracted upon installation. Secure the solenoids with the eight original T25 screws and tighten them to 4.5Nm (40 in-lbs).

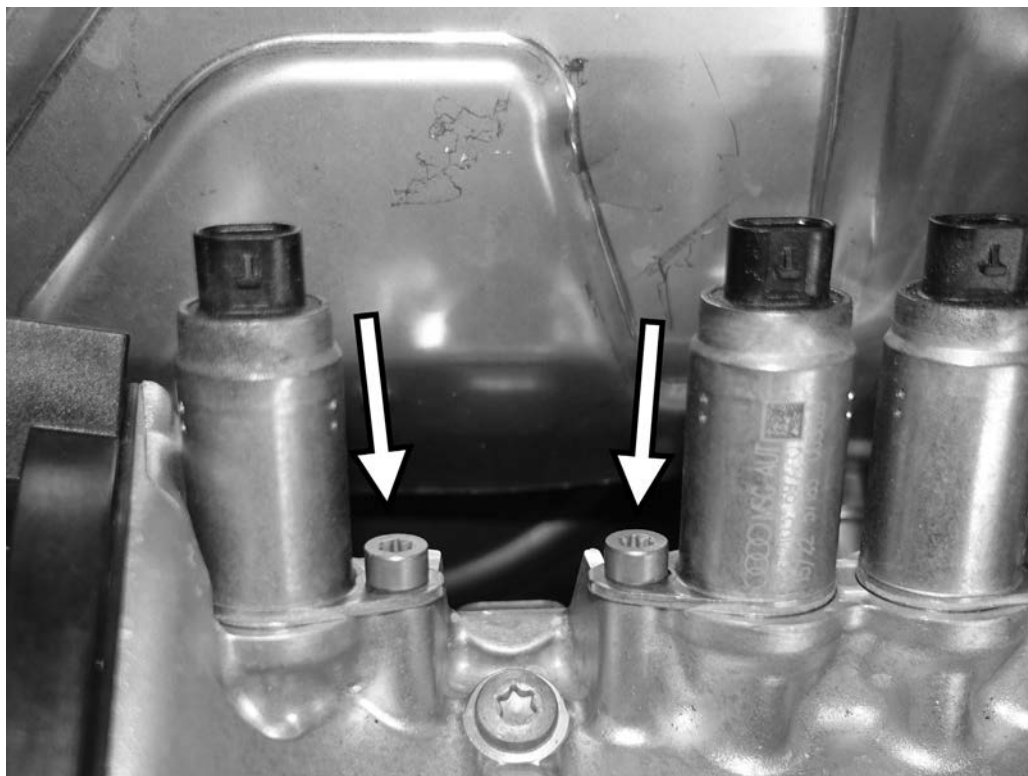

TL100191

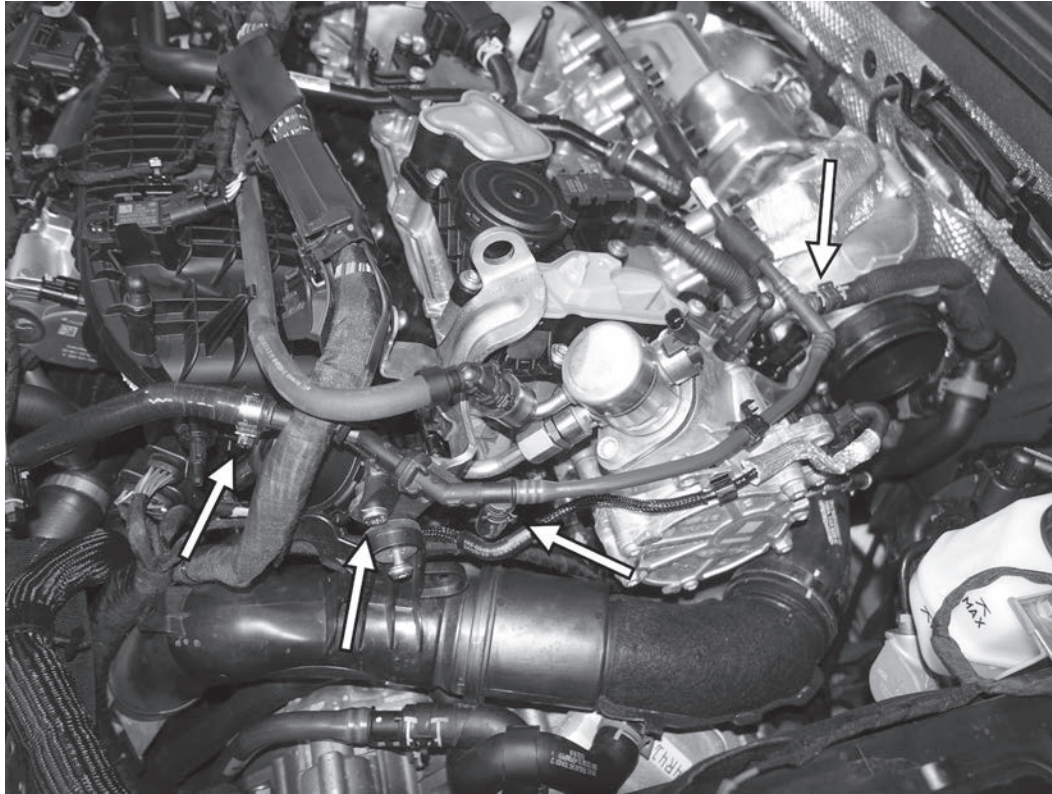

51) Reinstall the coolant vent line to the engine, being careful not to bend the line. Reconnect the two tee fittings behind the number four cylinder and one in front of the high pressure fuel pump. Reconnect the hard coolant line from the coolant hose that runs by the factory airbox. Finally, install the T30 screw by the charge pipe mounting point and tighten to 9Nm (80 in-lbs).

52) Reconnect the coolant line to the top of the coolant expansion tank. Reconnect the tee fitting on the coolant line behind the number two cylinder. Reinstall the T30 screw holding the coolant line to the top of the valve cover and tighten to 8Nm (71 in-lbs).



TL100191

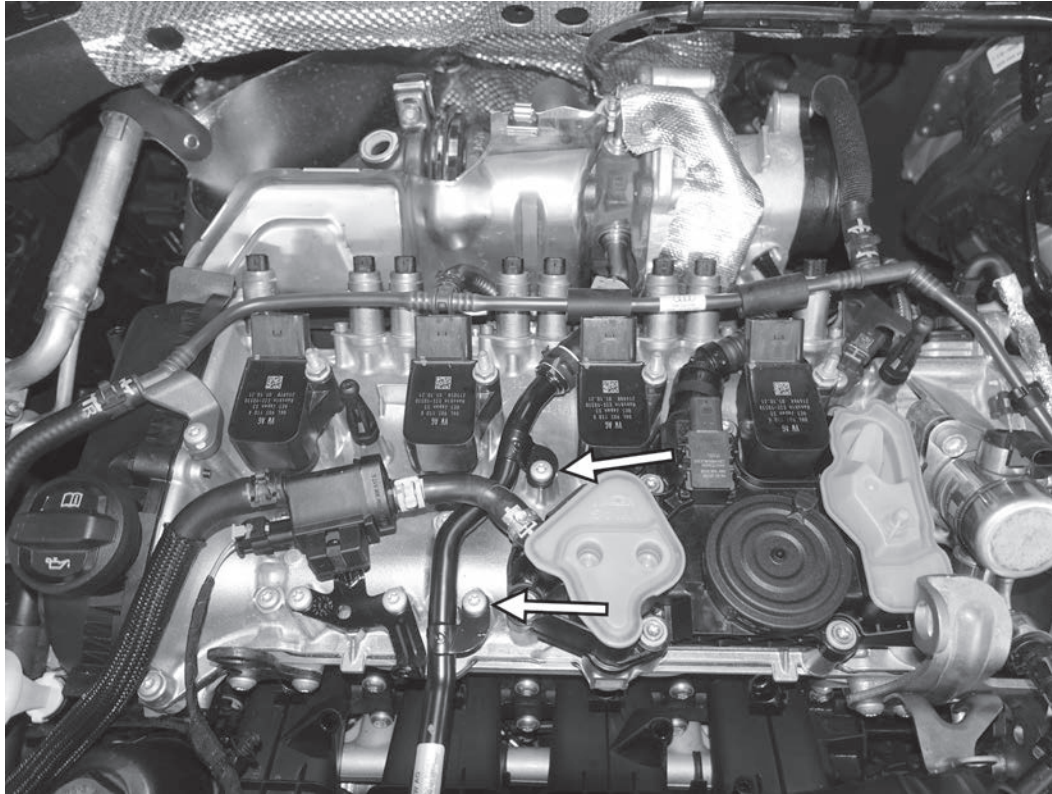

53) Reinstall the ignition coilpacks in the engine, but do not secure them. Reinstall the two T30 screws holding the turbo coolant return line to the top of the valve cover. Tighten both screws to 8Nm (70 in-lbs).

54) Lay the wiring harness back into its original location at the back of the engine. Reconnect the electrical connector to the high pressure fuel pump and the turbo speed sensor on the back of the turbo (inset). Reconnect all 8 connectors to the valvelift solenoids. Reconnect the two cam actuators and reattach the clip on the back of the timing chain cover.



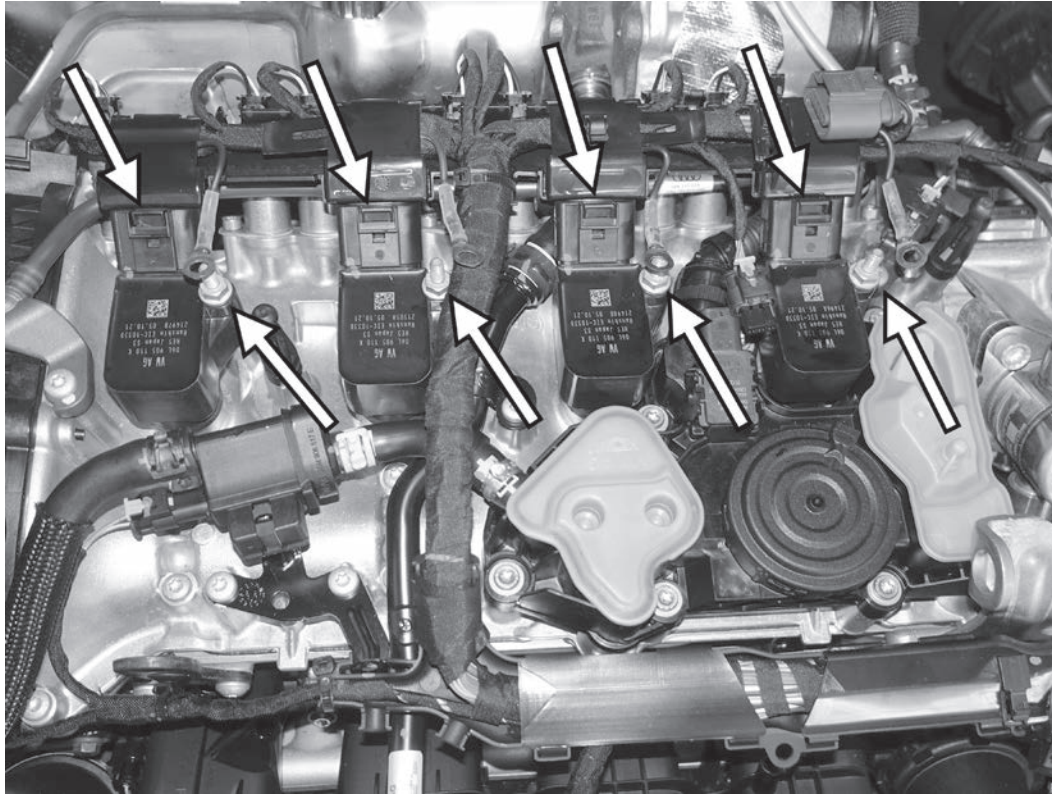

55) Secure the four ignition coil packs with the four original 10mm threaded studs. Tighten the studs to 9Nm (80 in-lbs). Reconnect all four electrical connectors to the back of the coil packs.

56) Reinstall the ground strap connections to all four threaded studs on the coilpacks and lightly secure with the 10mm nuts. While holding the 10mm threaded stud with a thin wrench, tighten the 10mm nuts to 9Nm (80 in-lbs). Reconnect the electrical connectors to the pressure sensor on the PCV and the camshaft position sensor.



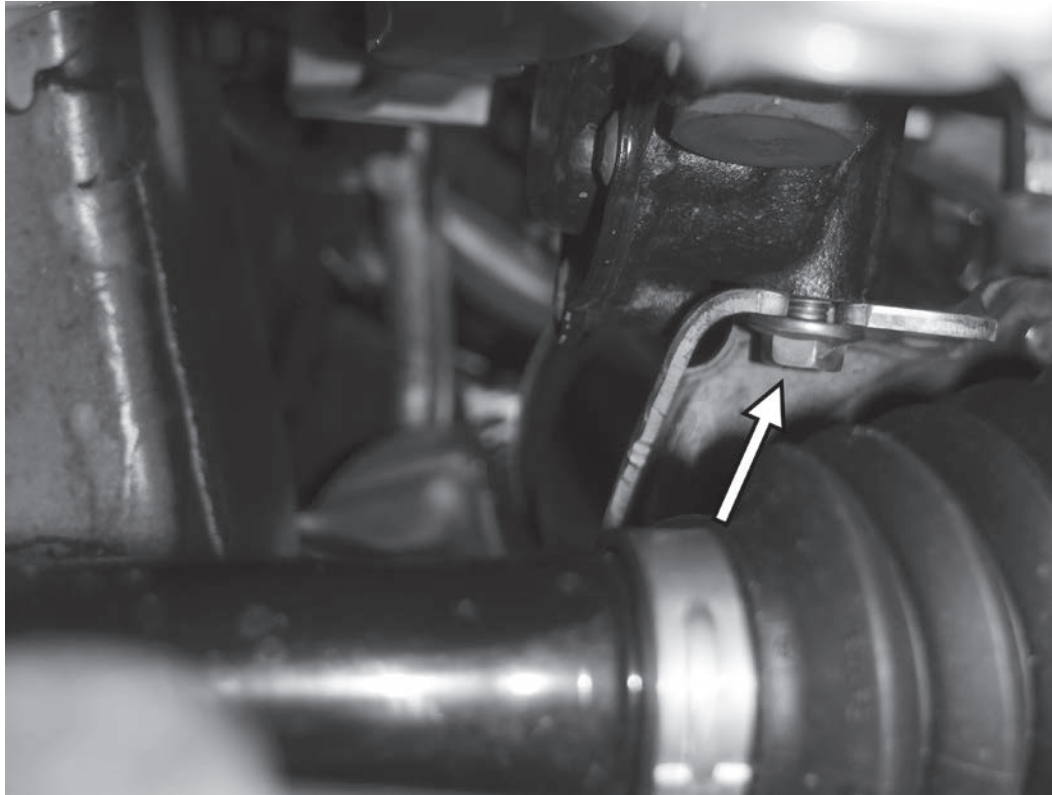

57) Place the downpipe back up against the turbine outlet of the turbo and loosely reinstall the v-band clamp. From underneath, loosely install the 13mm screw holding the downpipe bracket to the back of the engine block.

58) With the 13mm lower screw installed, fully tighten the 6mm allen screw on the v-band clamp to 15Nm (133 in-lbs). Once the v-band is tightened, tighten the 13mm lower screw on the downpipe bracket to 20Nm (177 in-lbs).



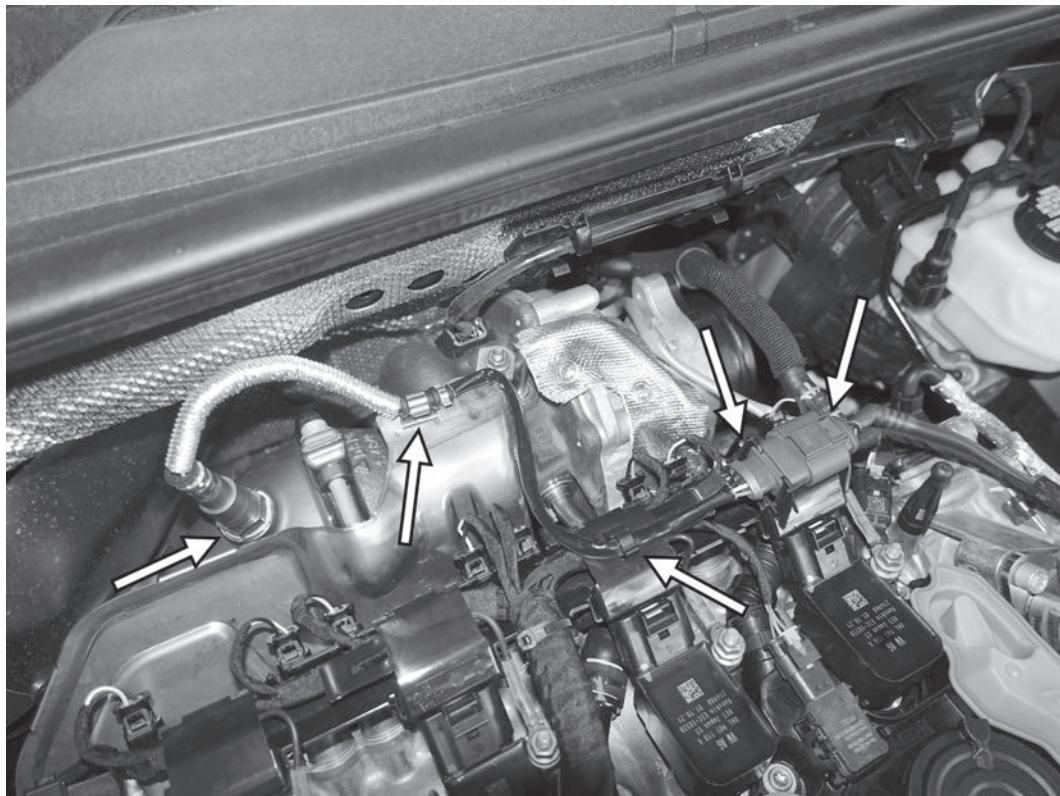

59) Reinstall the primary oxygen sensor into the stock downpipe with an oxygen sensor socket. Tighten the sensor to 60Nm (44 ft-lbs). Then route the harness for the sensor back to its original connection point, recliping the harness into the mounting points. Reconnect the harness connector, and place back into the bracket for the connector.

60) From the stock GTI turbo, remove the three T30 screws holding the diverter valve to the turbo and remove the diverter valve.

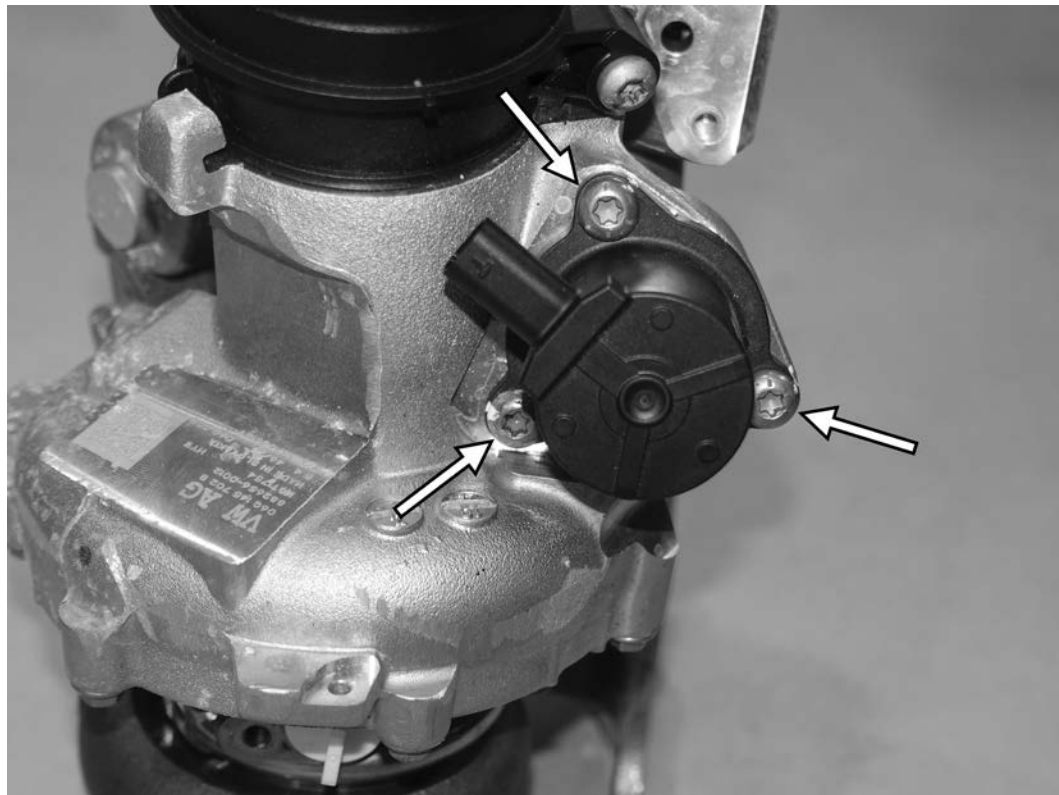

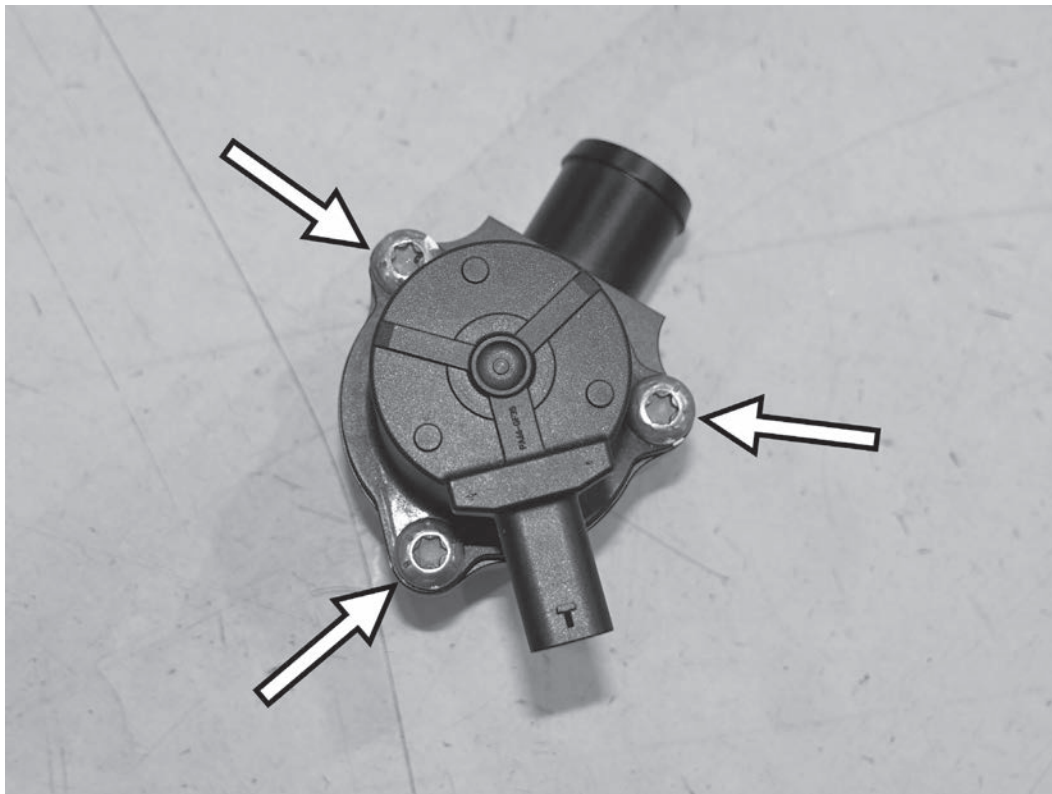

61) Install the previously removed diverter valve into the APR DV adapter and secure with the three original T30 screws, tightening the screws to 9Nm (80 in-lbs).

APR

62) Install the U-shaped hose onto the outlet of the APR DV adapter as shown, ensuring the APR hose part number is nearest the adapter. Secure the clamp to the adapter to 4Nm (35 in-lbs).

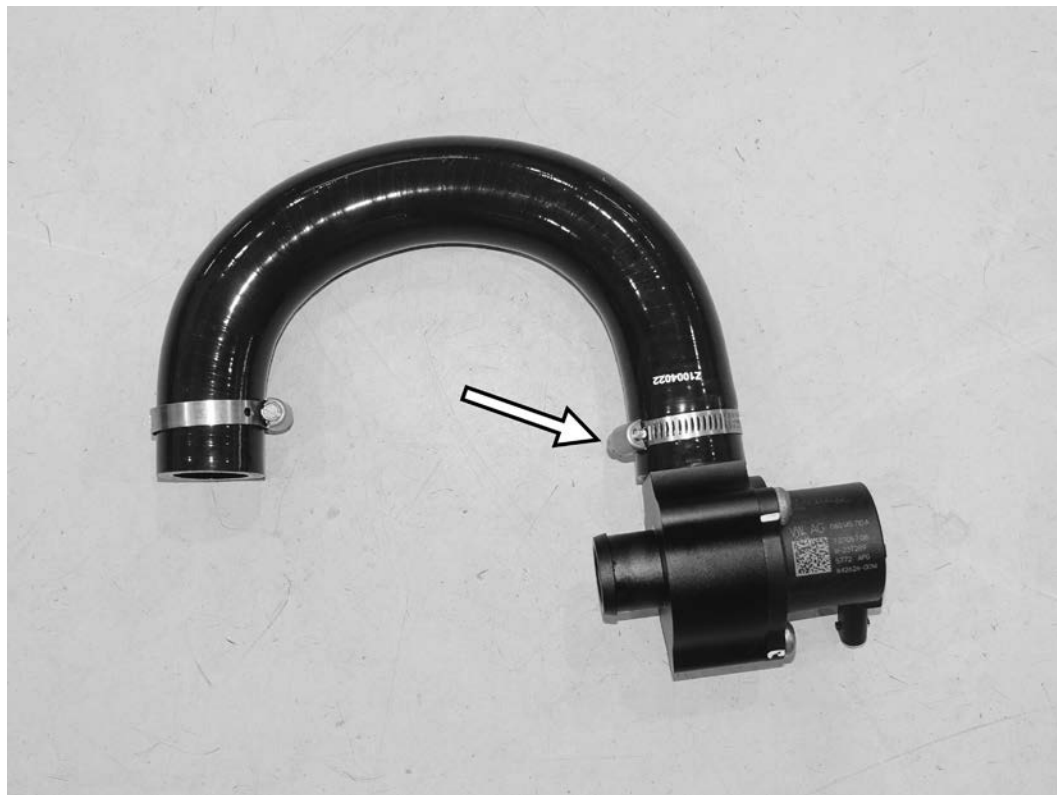

TL100191

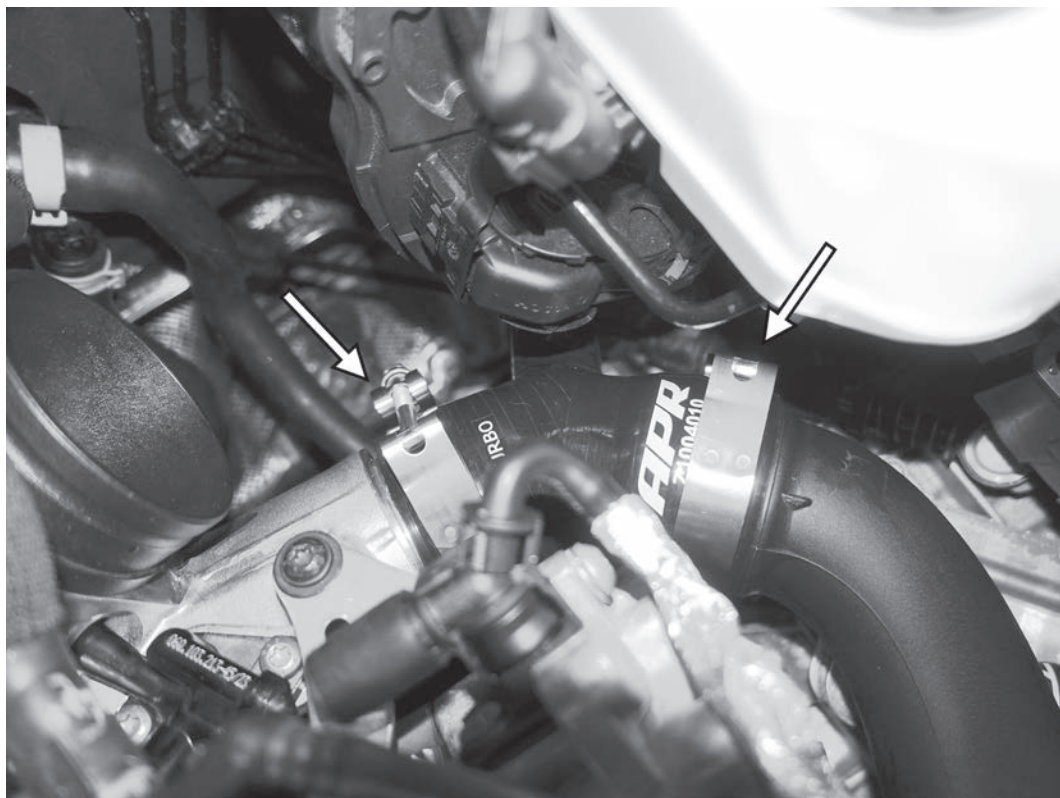

63) Install the APR turbo outlet hose between the outlet of the turbo and the side charge pipe. The end of the hose marked "TURBO" should be facing up and closest to the turbo outlet. Secure with the two t-bolt clamps, tightening them to 8.5Nm (75 in-lbs).

APR

64) Install the bottom side of the APR DV adapter into the port on the side of the APR turbo outlet hose. Orient the APR DV adapter as shown, so the U-shaped hose has both openings facing the turbocharger. Secure the APR DV adapter to the turbo outlet hose with one of the screw clamps, tightening it to 4Nm (35 in-lbs).

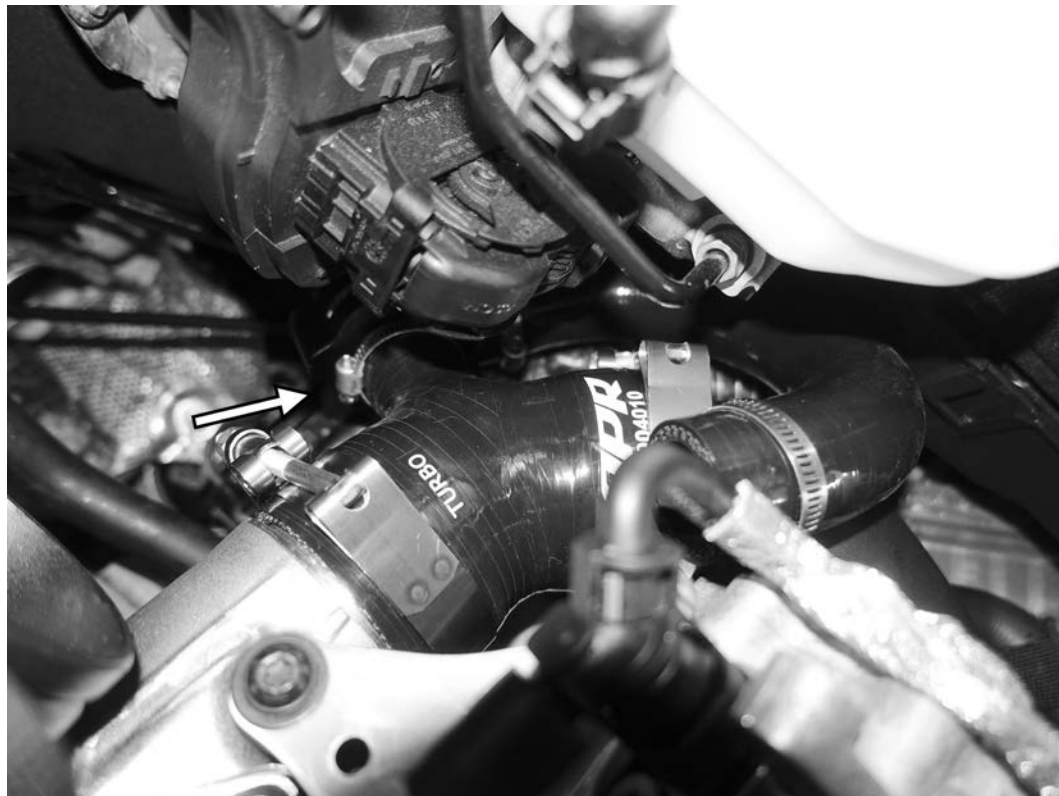

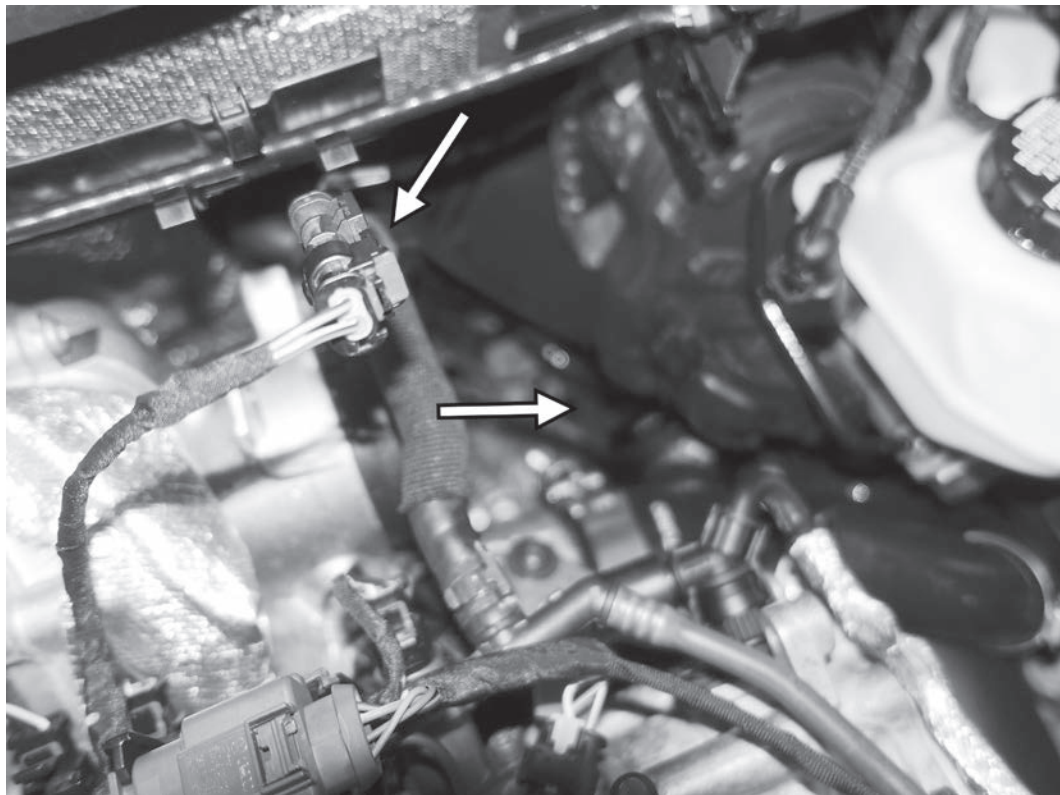

65) Connect the APR DV extension harness between the factory DV connector and the electrical connector on the factory DV.

APR

66) Reinstall the T30 screw holding the turbo outlet pipe to the side of the engine. Tighten the screw to 7Nm (62 in-lbs). Reattach the wiring harness to the turbo outlet pipe.



TL100191

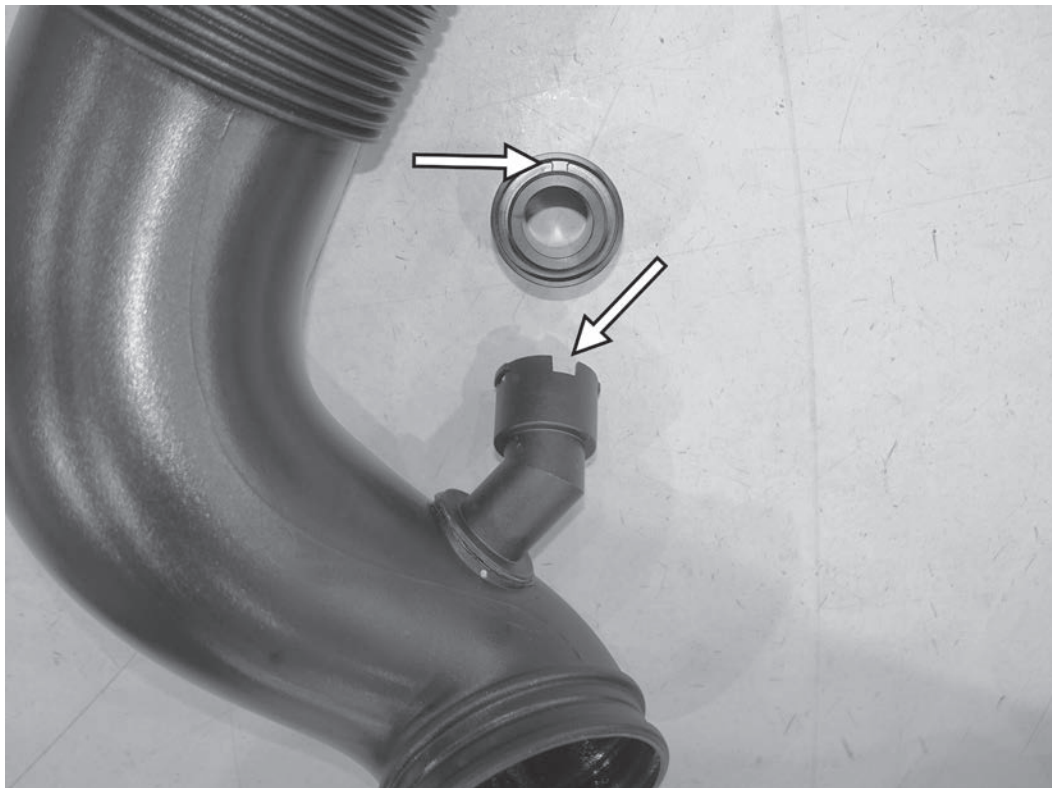

67) Install the APR DV hose adapter into the turbo intake pipe of the car. Note the raised tab on the inside of the adapter keys into the biggest cutout of the DV port of the turbo intake pipe.

APR

68) Secure the APR DV hose adapter into the turbo intake pipe with the supplied spring clip. Slide the spring clip into the slots on the sides of the adapter. Note that the adapter will not be secure if you did not properly align the notch with the raised tab inside the adapter, as shown in the previous step.



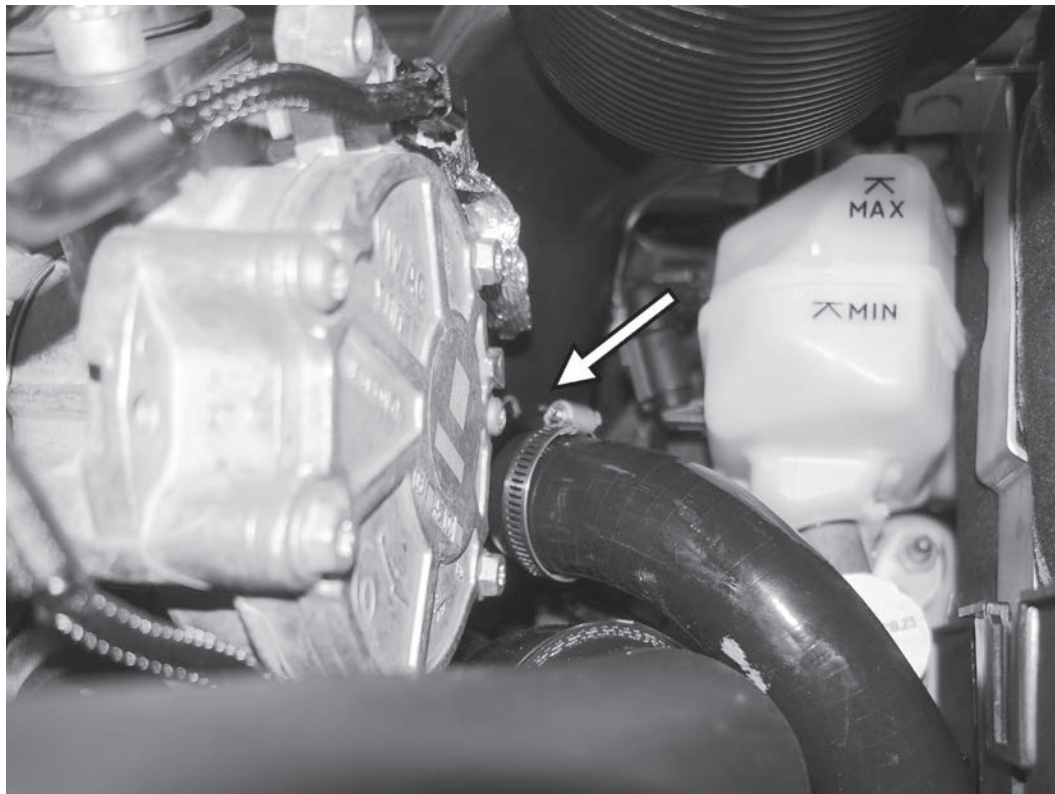

69) Place the turbo inlet pipe onto the car, connecting the APR DV hose adapter on the turbo inlet pipe into the open end of the U-shaped hose from the DV. Secure with the supplied screw clamp to 4Nm (35 in-lbs).

70) Reinstall the airbox assembly by first attaching it to the tabs on the back of the radiator core support, and then fully pushing it down on the three posts underneath. Reinstall the two T25 screws on the front of the APR airbox and tighten them to 2Nm (18 in-lbs). Install the inlet pipe onto the back of the airbox, and tighten the 7mm nut on the clamp to 6Nm (53 in-lbs).



TL100191

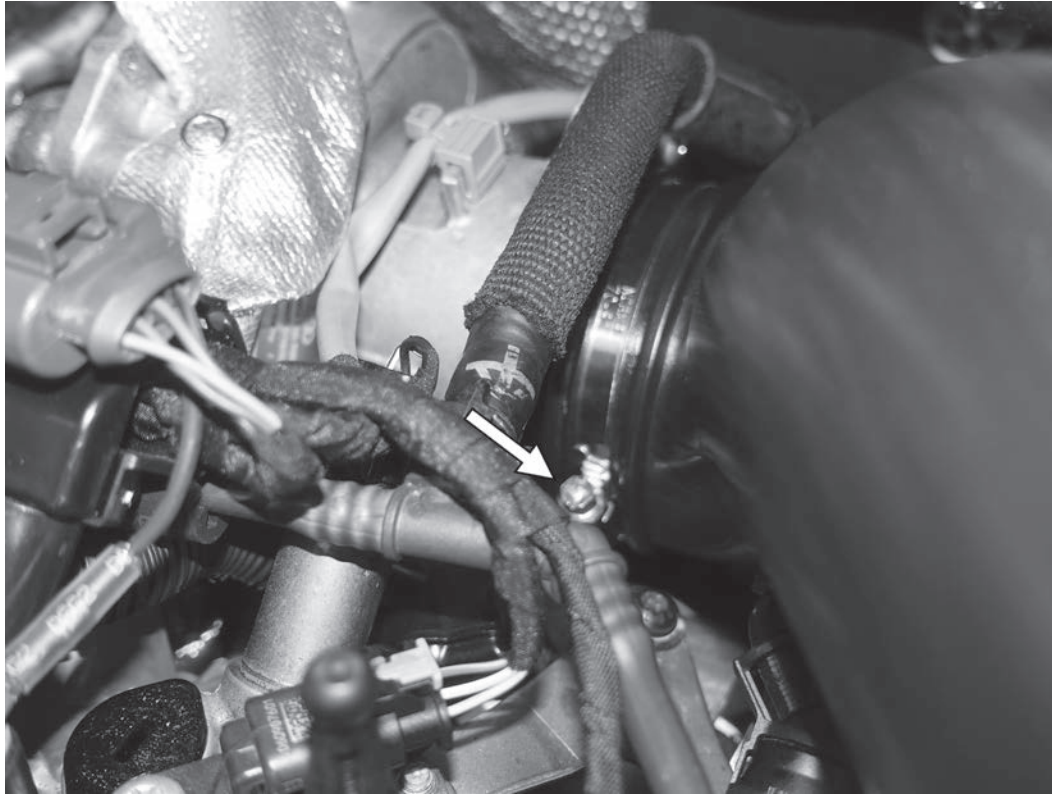

71) Once the airbox is in place, ensure there is no stress on the APR inlet pipe. Then secure the APR inlet pipe to the APR turbo inlet adapter by tightening the clamp to 6Nm (53 in-lbs).

APR

72) The APR DV extension wiring harness can be tucked into the oxygen sensor wiring harness on the front of the firewall.



TL100191

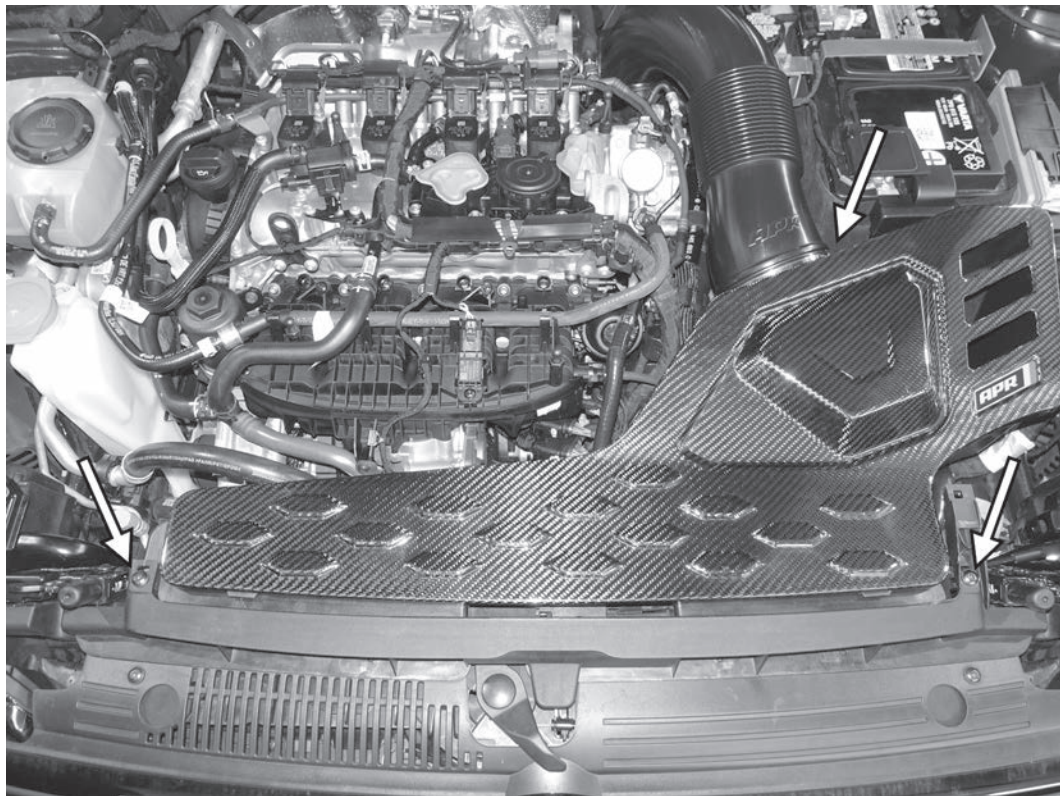

73) Reinstall the airbox assembly by first attaching it to the tabs on the back of the radiator core support, and then fully pushing it down on the three posts underneath. Reinstall the two T25 screws on the front of the APR airbox and tighten them to 2Nm (18 in-lbs). Install the inlet pipe onto the back of the airbox, and tighten the 7mm nut on the clamp to 6Nm (53 in-lbs).

APR

#TL100191

GO APR.COM